



**PUBLIC BUILDINGS
EARTHQUAKE RESISTANCE & ENERGY EFFICIENCY PROJECT
(SREEPB PROJECT)**

**MINISTRY OF YOUTH AND SPORTS
KOCAELİ KANDIRA SPECIAL PROVINCIAL ADMINISTRATION KYK
DORMITORY**

OCCUPATIONAL HEALTH AND SAFETY PLAN

MARCH
2024

**PERSONAL DATA PROCESSING RULES**

With respect to the personal data in this document, with "Law on Protection of Personal Data" (Official Gazette Date: 07.04.2016 Official Gazette Number: 29677);



The individuals in question have been informed about the following matters.

- Data Controllers,
- For what purpose personal data will be processed,
- Relevant sections of this document where personal data are processed,
- To whom and for what purpose the processed personal data can be transferred.



The real and legal persons reviewing this document must strictly adhere to the rules set out below;

- To prevent unlawful processing of personal data,
- To prevent unlawful access to personal data,
- To take all necessary technical and administrative measures to ensure the appropriate level of security to ensure the preservation of personal data,

Table of Contents

1. Terms & Abbreviation	7
2. Objective	8
3. Scope.....	8
4. Legal Regulations	9
5. Management Commitment & OHS Objectives.....	11
5.1. Management Commitment.....	11
5.2. Policy	12
5.2.1 Key Strategies Related to OHSP.....	12
5.3. Targets	13
6. Project Information	15
6.1. General Information.....	15
6.1.1 Buildings within the Scope of the Project.....	15
6.2 Pre-construction Information & Site Plans	19
6.3 General Construction Site Rules	19
7. Health & Safety Organization.....	24
7.1. Consultant	25
7.1.1. Duties of the Project Manager	25
7.1.2. Duties of the OHS Specialist	26
7.1.3. Duties of Occupational Physicians	28
7.1.4. OHS Duties of Technical Experts.....	31
7.1.5. OHS Duties of the Social Specialist	31
7.1.6. Duties of Support Staff	31
7.2 Contractor Company.....	32
7.2.1. Employer and Employer Representative Duties	32
7.2.2. Duties of the OHS Specialist	32
7.2.3. Duties of Subcontractor Workplace Physicians	33
7.2.4. Technical Experts' OHS Duties.....	33
7.2.5. Employee Representative Duties	33
7.2.6. Support Personnel Duties:.....	34
8. Management of Works.....	35
General Work Program and Cross Interaction	35
8.1 Working Methods	36
8.1.1 Structural Reinforcement	36
8.1.2 Energy Efficiency	56
9. Determination of Risks & Control Measures.....	75
9.1 Determination of Risks and Control Measures Affecting the General Construction Site.....	75
9.2 Determining Possible Business-Related Risks and Control Measures and Evaluating the Impact on Third Parties.....	75
9.3 Risks Arising from Overlapping Tasks in Terms of Time and Space.....	76
10. Determining Work Equipment Needs and Specifications.....	77
10.1 Determination of Protective Equipment Needs.....	78
10.1.1 Collective protection Systems.....	78

10.1.2 Personal Protective Equipment	79
11. Work Permit System	80
Use of the Form	81
12. LOTO System	84
13. Observation and Inspection.....	85
14. Employee Training.....	92
Monitoring Personnel Health Conditions	92
Personnel Professional Competence	92
15. Emergency Preparedness	93
Muster Points	96
Emergency Response Teams and First Aid Personnel.....	96
16. Accident and Incident Investigation	97
Post-Accident Considerations;.....	98
17. OHS Budget.....	99
Annex-1 Traffic Plan, Emergency Gathering Area, Risky Areas	100

Index

Table 1 List Of Relevant Legal Regulations (Law)	9
Table 2 List Of Relevant Legal Regulations.....	9
Table 3 Consultant Information Table	15
Table 4 KOCAELİ KANDIRA SPECIAL PROVINCIAL ADMINISTRATION KYK DORMITORY (Campus No: 11) Building List	15
Table 5 Kocaeli Kandira Special Provincial Administration Kyk Dormitory General Information Table	16
Table 6 Works Planned To Be Made In KANDIRA SPECIAL PROVINCIAL ADMINISTRATION KYK DORMITORY.....	17
Table 7 Works Planned To Be Made In KANDIRA SPECIAL PROVINCIAL ADMINISTRATION KYK DORMITORY	18
Table11: General Work Program.....	35
Table 12: Building Strengthening & Superstructure Works Control Table.....	43
Table 13: RISK ANALYSIS	45
Table 14 Roof Top PV Works Control Table	59
Table 15 RISK ANALYSIS.....	60
Table 16 KASKAD Sectional Condensing Premix Floor Type Boiler Plant Control Table	64
Table 19 RISK ANALYSIS.....	65
Table 18 Installation Of Motor Pump Combinations With Integrated Frequency Control Work Control Table	67
Table 19 RISK ANALYSIS.....	68
Table 20 Completing The LED Conversion Of Existing Lighting Elements Works Control Plan.....	70
Table 23 RISK ANALYSIS.....	70
Table 22 Plumbing Insulation Works Control Plan	72
Table 23 Electronic Building Management System & Automation System Works Control Plan.....	73
Table 24 RISK ANALYSIS.....	74
Table 25: LIST OF COLLECTIVE PROTECTION SYSTEMS.....	78
Table 26: PPE TABLE.....	79
Table 27: OCCUPATIONAL HEALTH AND SAFETY (OHS) CONTROL CHECKLIST	85
Table 28 OHS Monitoring Plan	87
Table 29 Estimated OHS Budget.....	99
Figure 1 KOCAELİ KANDIRA SPECIAL PROVINCIAL ADMINISTRATION KYK DORMITORY (Campus No: 11).....	15
Figure 2 KANDIRA SPECIAL PROVINCIAL ADMINISTRATION KYK DORMITORY Temporary Storage Area.....	20
Figure 3: EMERGENCY ASSEMBLY AREAS	21
Figure 4 Building Exterior Doors	23
Figure 5 Phase Detector Sample Image	37
Figure 6 Pat Test Label Sample Image	37
Figure 7: Installing Anchor Rods Sample Image	38
Figure 8: Exterior Scaffolding Sample Image	41
Figure 9 Kocaeli- Ministry Of Youth And Sports Kandira Special Provincial Administration Kyk Dormitory Building Roof Top PV Layout Plan.....	56
Figure 10 Representative Picture Of Movement Restrictor	57
Figure 11 Representative Picture Of Movement Restrictor	58

Figure 12 Mobile Scaffolding Sample Demonstration	69
Figure 13 LOCKOUT TAGGING TRAINING SAMPLE	84
Figure 14 Kocaeli- Ministry Of Youth And Sports Kandira Special Provincial Administration Kyk Dormitory Traffic Plan	100
Figure 15 Kocaeli Gsb Kandira Special Provincial Administration Kyk Dormitory Emergency Assembly Area.....	101
Figure 16 KOCAELİ GSB KANDIRA PROVINCIAL SPECIAL ADMINISTRATION KYK DORMITORY Risky Areas.....	102

1. Terms & Abbreviation

Contractor	As a result of the tender held by the Ministry of Environment, Urbanization and Climate Change, the company is responsible for implementing all renovation activities focused on structural strengthening and energy efficiency.
Subcontractor	The company assigned by the contractor company to carry out a part of the project.
Consultant	Tumas & ATLASCert® & Hill Joint Venture
Corrective Action	A set of activities aimed at eliminating the root causes of identified non-conformities and unwanted conditions. <i>(It is mandatory to record corrective actions, including the date of identification, the identifier, responsible unit/persons, description of non-conformity and root cause, corrective action recommendations, deadlines, date of resolution of the non-conformity, and the method used.)</i>
Root Cause Analysis	When defining or assessing an incident, problem, or undesired outcome, it involves going beyond immediate causes and, upon addressing, identifying the main reasons or elements to prevent the recurrence of similar incidents or problems in the future. (Corrective actions should focus on eliminating or correcting these main causes or elements.)
Molucca	Ministry of Environment, Urbanization, and Climate Change
Major	Big, Very Important
PPE	Personal Protective Equipment
LOTO	Lock Out-Tag Out
PAT	Portable Appliance Test
MSDS	Material Safety Data Sheet
ERT	Emergency Response Team

2. Objective

WB/CS-DESSUP 01 Structural Feasibility, Energy Audit, Structural Energy Enhancement, Project Design, and Construction Supervision Consulting Services Project **STRUCTURAL STRENGTHENING and RENOVATION process**

- Statement of completion of services covering Highly Hazardous Works that must be obtained from External Agencies before the project-oriented Construction process begins.
- Determining the hazards and risks related to construction activities, as well as identifying safety measures to be taken,
- Establishing the minimum requirements for personnel involved in the construction process and preventing those who do not meet these minimum requirements from participating in the work, are the objectives.

In accordance with this objective, the following have been defined within this document;

- Construction method and risk analysis for the structural reinforcement and renovation process,
- Personnel qualification profiles,
- Control/inspection methods for before, during, and after fieldwork,
- Record forms and methods,
- Additional safety measures to be taken by beneficiary institutions
- Completion of the required operations within the External Supplier Organizations (Natural Gas Local Distribution Company, Electricity Local Distribution Company, Local Government Infrastructure and Technical Works Directorates) before the field delivery of the services in accordance with the Project and Rules in accordance with the Legislation.

It is defined within this document.

This Occupational Health and Safety Report prepared by our the consultant will be notified through official channels that the Contractor company should prepare its own OHS plan, Risk Assessments and Method declarations regarding the project-based operations to be carried out by taking the Occupational Health and Safety (OHS) Plan prepared by the Consultant as reference.

3. Scope

WB/CS-DESSUP 01 project, Kocaeli Kandira Special Provincial Administration Kyk Campus, consisting of 1 building, 23,316.59 m2 construction area, building list and satellite visuals are given under the title "Buildings within the Scope of the Project"

The works to be carried out within this project are described below. This document is limited to the studies listed below.

- Strengthening the structural elements,
- Facade and façade components, mechanical and electrical system renovations within the framework of energy efficiency,
- Sustainable clean energy production (Rooftop solar power plants),

4. Legal Regulations

This OHSP has been primarily prepared in accordance with the laws and regulations related to Occupational Health and Safety in Turkey. In addition to these, it also complies with the Environmental and Social Standards of the World Bank, particularly focusing on ESS2: Labor and Working Conditions and ESS4: Community Health and Safety. The list of relevant legal regulations is provided below.

Table 1 List Of Relevant Legal Regulations (Law)

	<u>NO</u>	<u>DATE OF APPROVAL</u>	<u>OFFICIAL GAZETTE NUMBER & DATE</u>
Labor Law (Current Version)	1475	25.08.1971	RG: 01.09.1971/13943
Labor Law	4857	22.05.2003	RG: 10.06.2003/25134
Labor Courts Law	7036	12.10.2017	RG: 25.10.2017/30221
Occupational Health and Safety Law	6331	20.06.2012	RG: 30.06.2012/28726
Misdemeanors Law	5326	30.03.2005	RG: 31.03.2005/25772 M.
Vocational Training Law	3308	05.06.1986	RG: 19.06.1986/19139
Law on Some Regulations Concerning the Vocational Qualifications Authority (Vocational Qualifications Authority Law)	5544	21.09.2006	RG: 07.10.2006/26312
Social Insurance and General Health Insurance Law	5510	31.05.2006	RG: 16.06.2006/26200
Social Insurance Law (Current Version)	506	17.07.1964	RG: 29.07.1964/11766
Law on the Preparation and Implementation of Technical Regulations for Products	4703	29.06.2001	RG: 11.07.2001/24459
European Convention on Human Rights (Universal Declaration of Human Rights)	207 A(III)	10.12.1948	RG: 27.05.1949/7217

Table 2 List Of Relevant Legal Regulations

	<u>OFFICIAL GAZETTE NUMBER & DATE</u>
Subcontracting Regulation	RG: 27.09.2008/27010 Değ. 25.08.2017/30165
Regulation on the Protection of Employees from Noise-Related Risks	RG: 28.07.2013/28721
Regulation on the Principles and Procedures of Occupational Health and Safety Training for Employees	RG: 15.05.2013/28648 Değ. 24.05.2018/30430
Regulation on the Principles and Procedures for Health Surveillance of Employees	RG: 20.01.2022/31725
Manual Handling Operations Regulation	RG: 24.07.2013/28717

Hygiene Training Regulation	RG: 05.07.2013/28698
First Aid Regulation	RG: 29.07.2015/29429
Regulation on Health and Safety Conditions for the Use of Work Equipment	RG: 25.04.2013/28628 Değ. 18.02.2022/31754
Regulation on the Duties, Authorities, Responsibilities, and Training of Occupational Health and Safety Specialists	RG: 29.12.2012/28512 Değ. 16.04.2020/31101
Regulation on Working Hours Related to the Labor Law	RG: 06.04.2004/25425 Değ. 25.08.2017/30165
Regulation on Overtime Work and Work with Extra Hours Related to the Labor Law	RG: 06.04.2004/25425 Değ. 25.08.2017/30165
Regulation on Occupational Health and Safety Risk Assessment	RG: 29.12.2012/28512
Regulation on the Duties, Authorities, Responsibilities, and Training of Workplace Physicians and Other Health Personnel	RG: 20.07.2013/28713 Değ. 16.04.2020/31101
Regulation on Emergency Situations in Workplaces	RG: 18.06.2013/28681 Değ. 01.10.2021/31615
Regulation on Work Stoppages in Workplaces	RG: 30.03.2013/28603 Değ. 11.02.2016/29621
Personal Protective Equipment Regulation	RG: 01.05.2019/30761
Regulation on the Use of Personal Protective Equipment in Workplaces	RG: 02.07.2013/28695
Machinery Safety Regulation (2006/42/EC)	RG: 03.03.2009/27158 Değ. 28.09.2014/29133
Regulation on Examination, Measurement, Evaluation, and Certification by the Vocational Qualifications Institution	RG: 15.10.2015/29503
Regulation on Health and Safety Signs	RG: 11.09.2013/28762
Regulation on Vocational Training for Workers Employed in Hazardous and Very Hazardous Jobs	RG: 13.07.2013/28706 Değ. 11.05.2017/30063
Dust Control Regulation	RG: 05.11.2013/28812

5. Management Commitment & OHS Objectives

5.1. Management Commitment

As the manager of the TÜMAŞ | Hill | ATLASCert® Partnership, I commit that throughout the duration of the seismic reinforcement and energy efficiency project in public buildings, covering the preparation and implementation phases until the completion of the project: The health and safety of employees and other stakeholders will be prioritized. All relevant legislation and defined requirements will be strictly adhered to. All necessary measures related to occupational health and safety will be taken promptly. Collective protection measures will be prioritized when determining and implementing precautions. Employee training and information regarding occupational health and safety will be emphasized. Adequate resources will be provided for occupational health and safety, and necessary expenses will not be spared. Employee suggestions and ideas will be taken into consideration in occupational health and safety practices. Necessary participation, idea exchange, and collaboration in the field of occupational health and safety will be ensured between management and employees. This plan has been prepared for the conditions of this construction site, its employees, and other stakeholders. It will be implemented throughout the project and updated when necessary. Adequate information about their responsibilities under this plan will be provided to all levels of employees, including the highest-level manager involved in the project, as well as visitors. I hereby commit to these principles and responsibilities.

Date : 04.04.2024

Name&Surname: Vecihe Arzu TÜRKER

Signature :

5.2. Policy

We will comply with national and international regulations, ensuring a healthy and safe working environment by;

- Promoting and fostering a culture of occupational health and safety among all stakeholders, encouraging continuous improvement.
- Taking all necessary measures within the framework of occupational health and safety regulations for all relevant parties.
- Working to prevent workplace accidents through effective risk assessment before they occur.
- Providing training for our employees in occupational health and safety that goes beyond regulatory requirements.
- Respecting the rights of our employees, including their rights related to collective bargaining and negotiations, and supporting such initiatives.
- Adopting references such as the Universal Declaration of Human Rights, International Labor Organization (ILO) conventions, United Nations Global Compact, United Nations Sustainable Development Goals, and the Organization for Economic Cooperation and Development (OECD) guidelines for multinational enterprises.
- Ensuring that visitors at all levels, our suppliers, and employees of the companies from which we purchase services comply with occupational health and safety rules.
- Creating a healthy environment where employees feel comfortable, safe, and happy to work and taking mental health issues seriously, providing support to all personnel facing such problems.

Date : 04.04.2024

Name&Surname: Vecihe Arzu TÜRKER

Signature :

5.2.1 Key Strategies Related to OHSP

- Leadership from management teams,
- Involving all employees by seeking their opinions and suggestions to contribute to OHS requirements and problem-solving,
- Identifying hazards and planning and implementing adequate control measures before workplace accidents occur,
- Ensuring that all employees have sufficient awareness and motivation regarding occupational health and safety.

5.3. Targets

To regularly measure the Occupational Health and Safety (OHS) performance of the project, "performance criteria" consistent with the project contract have been established, along with measurable "targets" corresponding to each performance criterion, which will be tracked on a monthly basis. During the first week of each month, the OHS Monthly Activity Report, approved by the consultant in the appropriate format for the previous month, will be prepared and submitted to the administration.

TARGET DEFINITION	QUANTITATIVE DATA
Number of Lost-Time Occupational Accidents (maximum)	0
Number of Lost-Time Occupational Injuries (maximum)	0
Number of Near-Miss Incidents (maximum)	2
Accident Frequency Rate (AFR ¹) (maximum)	60
Accident Severity Rate (ASR ²) (maximum)	0
Occupational Health and Safety (OHS) Training for this Project	20 person.hour
Fire Drill for this Project	1 pcs.
Earthquake Drill for this Project	1 pcs.
Injured Worker Rescue Drill for this Project	1 pcs.

Performance criteria are continuously monitored cumulatively throughout the project duration. The values achieved in comparison to the planned targets are analyzed on a monthly basis to identify deviations and initiate necessary corrective actions. Data and results related to the targets will be communicated to the consultant during the first week of each month, along with the Occupational Health and Safety (OHS) Monthly Activity Report.

$$^1 \text{ AFR} = \frac{\text{Total Number of Accidents}}{\text{Total Working Time (hours)}} \times 1.000.000$$

$$^2 \text{ ASR} = \frac{\text{Total Number of Lost Days}}{(\text{Total Working Days} - \text{Non-Working Days})} \times 1.000$$

The questions that will be addressed as part of the performance measurement are as follows:

- Are we achieving our Occupational Health and Safety (OHS) targets?
- Are we working in compliance with OHS regulations?
- Are the planned control activities resulting from risk assessments effective in reducing risks?
- Are accidents and near-miss incidents being recorded? Is accident investigation and root cause analysis conducted to prevent their recurrence?
- Are Corrective Actions planned and implemented for discrepancies/violations identified in the field (by the Contractor or Consultant)?
- Are the implemented Corrective Actions effective?
- Are necessary changes (revisions) made to the OHSP when needed?
- Do the provided training sessions effectively build OHS awareness and motivation among employees?

To enable the consultant to monitor the Contractor's OHS performance, the following records will be shared by the Contractor on a monthly basis:

- Accident and near-miss incident reports (including Covid-19)
- Records related to mandatory training (training records, certificates, etc.)
- Periodic inspection reports for machinery/equipment (reports prepared by an A-type inspection organization accredited by TÜRKAK)
- Status of ISG-related discrepancies recorded by the Contractor or Consultant (open/closed, description of corrective actions, etc.).

6. Project Information

6.1. General Information

Information about the consultant company is given in the table below.

Table 3 Consultant Information Table

CONSULTANT	TÜMAŞ TÜRK MÜHENDİSLİK MÜTEAHHİTLİK VE MÜŞAVİRLİK A.Ş.
SSI REGISTRY NUMBER	271120202003584600607-24/000
ADDRESS	TUNUS CADDESİ NO: 43 KAVAKLIDERE/ANKARA
PHONE / E-MAIL	0(312) 417 60 25 (Pbx) / tumas@tumas.com.tr
OCCUPATIONAL HEALTH AND SAFETY EXPERT	Cem AKKUŞ İGU-50220
İŞYERİ HEKİMİ	Nail Kireçtepe İH-3668

6.1.1 Buildings within the Scope of the Project

Table 4 KOCAELİ KANDIRA SPECIAL PROVINCIAL ADMINISTRATION KYK DORMITORY (Campus No: 11) Building List

	<u>BİNA ADI</u>	<u>BÖLGE</u>	<u>İNŞAAT YILI</u>	<u>BİNA İNŞAAT ALANI m²</u>
01	KOCAELİ KANDIRA SPECIAL PROVINCIAL ADMINISTRATION KYK DORMITORY	KOCAELİ	2007	11.883,57
				11.883,57

Figure 1 KOCAELİ KANDIRA SPECIAL PROVINCIAL ADMINISTRATION KYK DORMITORY (Campus No: 11)



General information about the buildings in question is presented to your attention on the next page.

Table 5 Kocaeli Kandira Special Provincial Administration Kyk Dormitory General Information Table

BUILDING NAME	Kocaeli Kandira Special Provincial Administration Kyk Dormitory		
BUILDING OWNER	MINISTRY OF YOUTH AND SPORTS		
ADDRESS	ORHAN, 41600 KANDIRA/KOCAELİ		
CITY	KOCAELI	POSTAL CODE	41600
CONSTRUCTION YEAR	2007	CONSTRUCTION AREA	11.883,57 m ²
PURPOSE OF USAGE	Student Dormitory	NUMBER OF BLOCKS IN THE BUILDING GROUP	3
USABLE INDOOR SPACE	~11.883,57 m ²	TOTAL CLOSED VOLUME	40.541,99m ³
NUMBER OF USERS	TOTAL	185.400 Person/Year	
TECHNICAL RESPONSIBLE	NAME SURNAME	Burak YAŞA	
	CONTACT INFORMATION	PHONE	0090 (262) 452 16 87
		E-MAIL	kandira@gsb.gov.tr
THE PLANNED WORKS TO BE CARRIED OUT IN THE BUILDING			
All of the manufacturing planned to be done in the building are listed in Table 7.			
DURATION AND SEASON OF THE WORKS			
With the preparation of the tender documents, it is planned that the <u>Contractor will complete the manufacturing of the Kocaeli Kandira Special Provincial Administration Kyk Dormitory within 3-5 months following the site delivery date.</u> Due to the uncertainty of the site delivery time, a clear season cannot be specified and the work will be completed following the tender process planned to take place in 2024.			
NUMBER OF WORKERS EXPECTED TO WORK DURING THE RENOVATION WORKS			
In order to complete the planned construction activities within the targeted timeframe, it is estimated that 15 workers per day will be employed.			

Building Height : ~ 10,75 m (Vertical distance from ground level to the highest point of the building)

Number of Floors : 2+1 (Entrance floor)

3D Model : [CLICK TO ACCESS THE MODEL³](#)

On the next page, the planned construction activities, the estimated number of personnel, and completion durations are presented in a table format. This table is provided for general information purposes, and it is expected that the contracting company will revise this table according to its own work program/plans.

Table 6 Works Planned To Be Made In KANDIRA SPECIAL PROVINCIAL ADMINISTRATION KYK DORMITORY

	GENERAL DESCRIPTION OF THE WORK TO BE DONE	PROJECTED NUMBER OF PERSONNEL	PROJECTED DURATION (WEEKS)
STRUCTURAL REINFORCEMENT	WALL DEMOLITION & DISMANTLING WORKS	10	3
	ELECTRICAL AND MECHANICAL SYSTEM DEMOLITION	8	3
	SUBSTRUCTURE CONCRETE DEMOLITION AND FOUNDATION FILLING	10	2
	EPOXY ANCHORS AND TESTING	6	3
	NEW REINFORCEMENT INSTALLATION	10	4
	FORMWORK AND CONCRETE CASTING	10	3
FINISHING WORKS	WALL CONSTRUCTION	8	3
	PLASTERING	8	5
	PAINING	4	4
	FLOORING	3	5
	ELECTRICAL & MECHANICAL INSTALLATION	10	4
	AUTOMATION	3	3
OTHER WORKS	SOLAR PANEL INSTALLATION	6	1
	TESTING & INSPECTION	2	1

The works related to electrical & mechanical installations mentioned in Table 7, as well as the automation, and solar panel installation sections, include energy efficiency measures. These measures are listed below.

Table 7 Works Planned To Be Made In KANDIRA SPECIAL PROVINCIAL ADMINISTRATION KYK DORMITORY

GENERAL DESCRIPTION OF THE WORK TO BE DONE	PROJECTED NUMBER OF PERSONNEL:	PROJECTED DURATION (WEEKS)
Electricity generation with a rooftop monocrystalline PV system. • 240 pcs. Panel, 130.80 kWp System Weight: 8 TONS System Area: 650 m2	10	4
Scraping the existing insulation, replacing it with 10cm rock wool thermal insulation (U value minimum 0.035W/m2K) to cover the entire structure and not create thermal bridges. (Application surface area 4.500m2)	10	3
16cm thick glasswool roofing mat, one side covered with aluminum foil, on unused hipped roof flooring. (The new mattress can be installed on top of the existing one by preserving the undamaged parts of the existing mattress.) Application surface area: 3000m2	10	2
Replacement of doors numbered 1,6 and 8, which were found to be single-glazed and uninsulated, with 4x16x4 double-glazed and thermally insulated doors (11m2 application area).	6	3
Covering the uninsulated plate heat exchangers (TANPERA ORW 3-21) in the heating system installation with a thermal insulation jacket. (2 plate heat exchangers, heat transfer surface area: 1.06m2). Thermostatic valve installation for all cast radiator honeycombs (314 valves, 32 spare parts).	3	1,5
1 Ventilation, 2 Pcs. Replacement of air conditioning unit motors with IE4 class motors, replacement of traditional belt pulley system with toothed belt pulley system, frequency converter installation for motors. 1.5kW 1 pc. 3.0kW 1Pc. 5.5kW 1Pc.	2	1
Replacement of all installation motors with integrated frequency controlled motors. (Fire booster will not be replaced) 11 motor & pump replacements	3	1
LED dönüşümü gerçekleştirilmeyen aydınlatma elemanlarının LED dönüşümlerinin yapılması. 56 Ad. 30x120 LED 52 Ad. Downlight LED	3	2
Establishing the energy management system covering all structures in accordance with EN ISO 50001 standard conditions, Establishing the energy monitoring system for electricity and natural gas units and ensuring that the consumption of all important energy users (Boiler, Air Conditioning Units, Ventilation Units, Motor, Lighting) can be independently monitored, Establishment of mechanical automation system.	1	1-16

6.2 Pre-construction Information & Site Plans

Regarding the campuses where the study will be carried out; site data, building approach areas, traffic action plans, temporary storage areas, work vehicles and machinery parking areas, and risky areas such as elevation differences are stated in ANNEX 1.

6.3 General Construction Site Rules

- The entry and exit of vehicles (including construction equipment) to the work areas and parking areas are specified in the Figure-15 section. (See also Annex 1).
- The buildings within the scope of the project are out of use during the activities. Therefore:
 - It is not possible to install a structure such as a container etc. within the scope of the construction site in the work areas.
- Specific areas for dining and resting of workers are not allocated. The areas within the buildings where workers can use for general and humane needs (such as toilets, break/rest areas, dining rooms, etc.) will be determined by the beneficiary institution's technical and administrative units and communicated to the contractor.
- Workers will not be accommodated within the campus area. The contractor and subcontractors will arrange suitable places (hotels, motels, etc.) for the accommodation of workers.
- Temporary storage areas (*outside of the buildings*) are specified on a building basis. Temporary storage is not allowed in areas other than those specified.

Figure 2 KANDIRA SPECIAL PROVINCIAL ADMINISTRATION KYK DORMITORY Temporary Storage Area

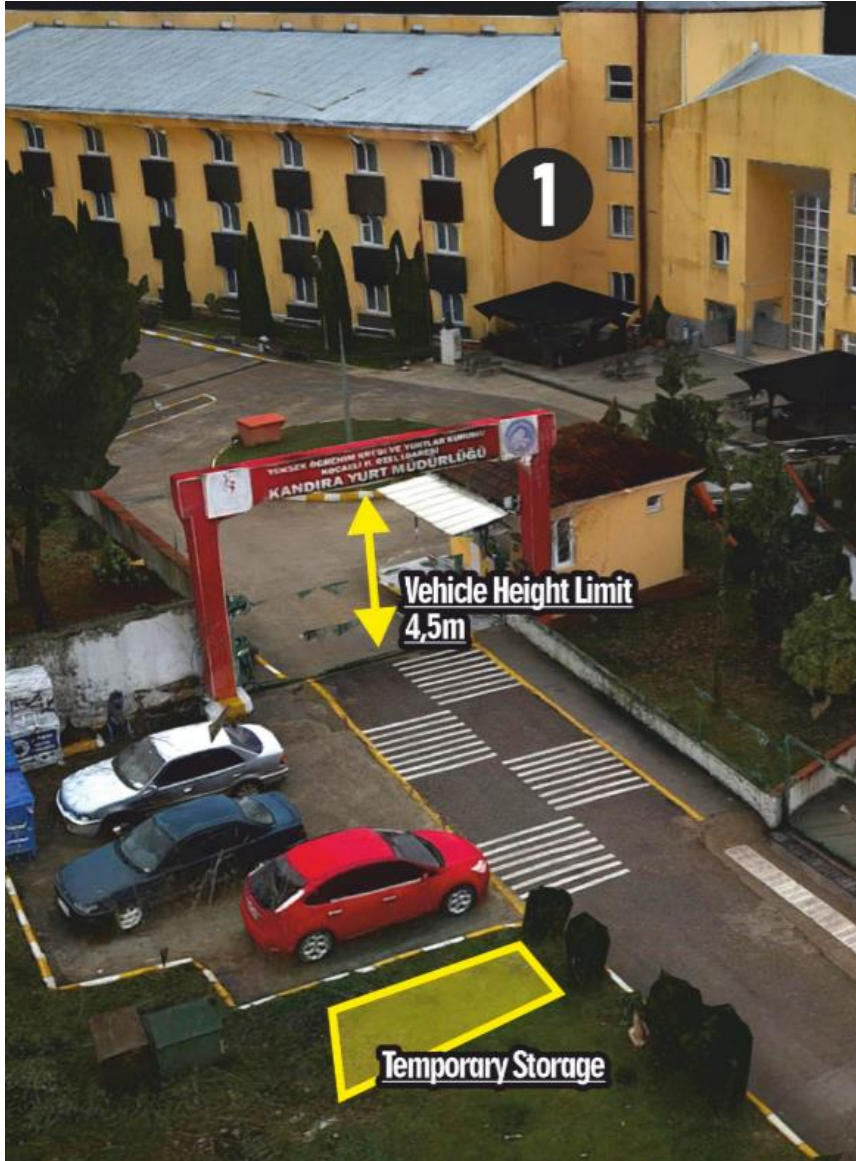

During temporary storage, the necessary precautions must be taken by the contracting company to stack materials and equipment in a way that does not create risks, protects them from environmental conditions, and prevents the leakage of hazardous chemicals into the ground. The contracting company must describe how these issues will be addressed before the use of these storage areas. Otherwise, the use of temporary storage areas will not be allowed.

- Emergency assembly areas for each building are specified below. Warning signs will be provided in these areas, and all employees will be informed about the assembly areas by the Occupational Health and Safety specialist.

Figure 3: EMERGENCY ASSEMBLY AREAS



- The specified emergency assembly areas will be used in all Occupational Health and Safety (OSH) drills. The responsible OSH Specialists will determine the emergency assembly times for each drill.
 - The emergency assembly areas will be included in the Occupational Health and Safety (OSH) training materials.
- Indoor toilets will be used for restroom needs.
 - Employees' shower needs will be provided in the accommodations arranged by the contractor and subcontractors (hotels, etc.). Indoor sinks will be used for washing hands.
 - Drinking water will be supplied to all employees in plastic bottles. It is not allowed to drink water from the toilets. Warning signs, as specified below, will be installed in all toilets.



- Smoking is prohibited inside the buildings and temporary storage areas. Warning signs, as specified below, will be installed at building entrances and temporary storage areas. (*An open flame prohibition sign will be installed in temporary storage areas.*)



- Outdoor smoking areas, located at least 5 meters away from building entrance doors, can be designated. These areas should be clearly marked with the warning sign specified below, and all employees should be informed about the designated smoking areas.



- All machinery and electrical equipment used during construction activities must bear the CE marking and comply with the relevant regulations. Products falling under the scope of the "CE" MARKING REGULATION and not meeting the requirements associated with this symbol are not permitted for use.

¹ Relevant Directives;

- MACHINERY SAFETY REGULATION (2006/42/EC)
- REGULATION ON ELECTRICAL EQUIPMENT DESIGNED FOR CERTAIN VOLTAGE LIMITS (2014/35/EU)
- PRESSURE EQUIPMENT REGULATION (2014/68/EU)
- REGULATION ON GAS-BURNING DEVICES (2016/426/EU)

Relevant standards (must be reviewed separately for each device.)

- TS EN ISO 12100 Safety in machinery - General principles for design - Risk assessment and risk reduction
- TS EN 60204-1 Safety in machines – Electrical equipment of machines – part 1: General rules
- TS EN 60335-1 Safety rules - For electrical devices used in homes and similar places - Part 1: General rules
- TS 1203 EN 286-1 Tanks – Simple – Non-flammable – Pressurized
- TS 10116 Cranes – Test and inspection methods
- TS ISO 9927-1 Cranes-Inspections-Part 1: General

The building is entered through 2 external doors. The locations, types and general images of the doors in question are given below.

Figure 4 Building Exterior Doors

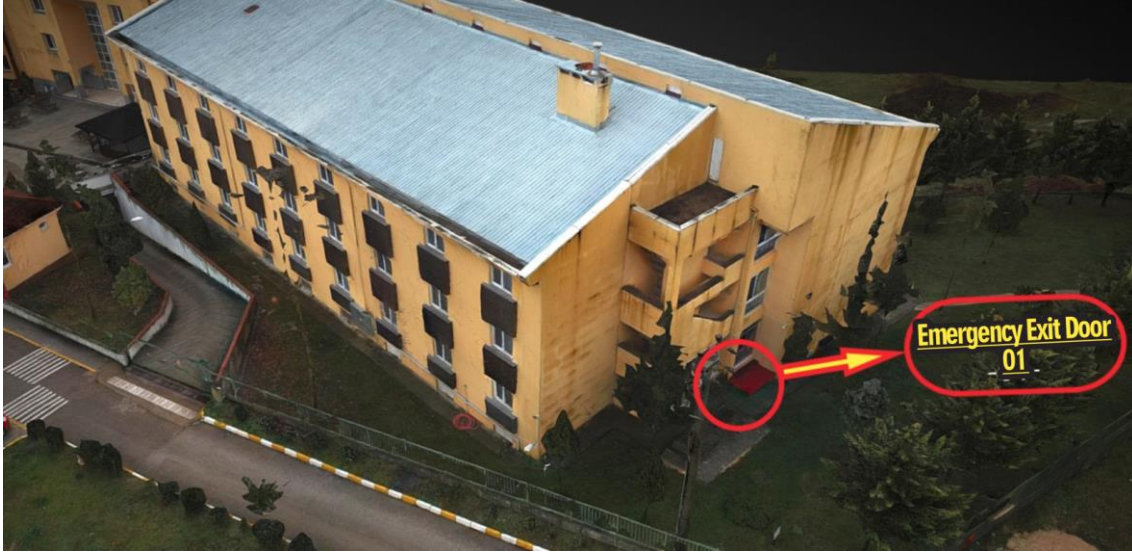

7. Health & Safety Organization

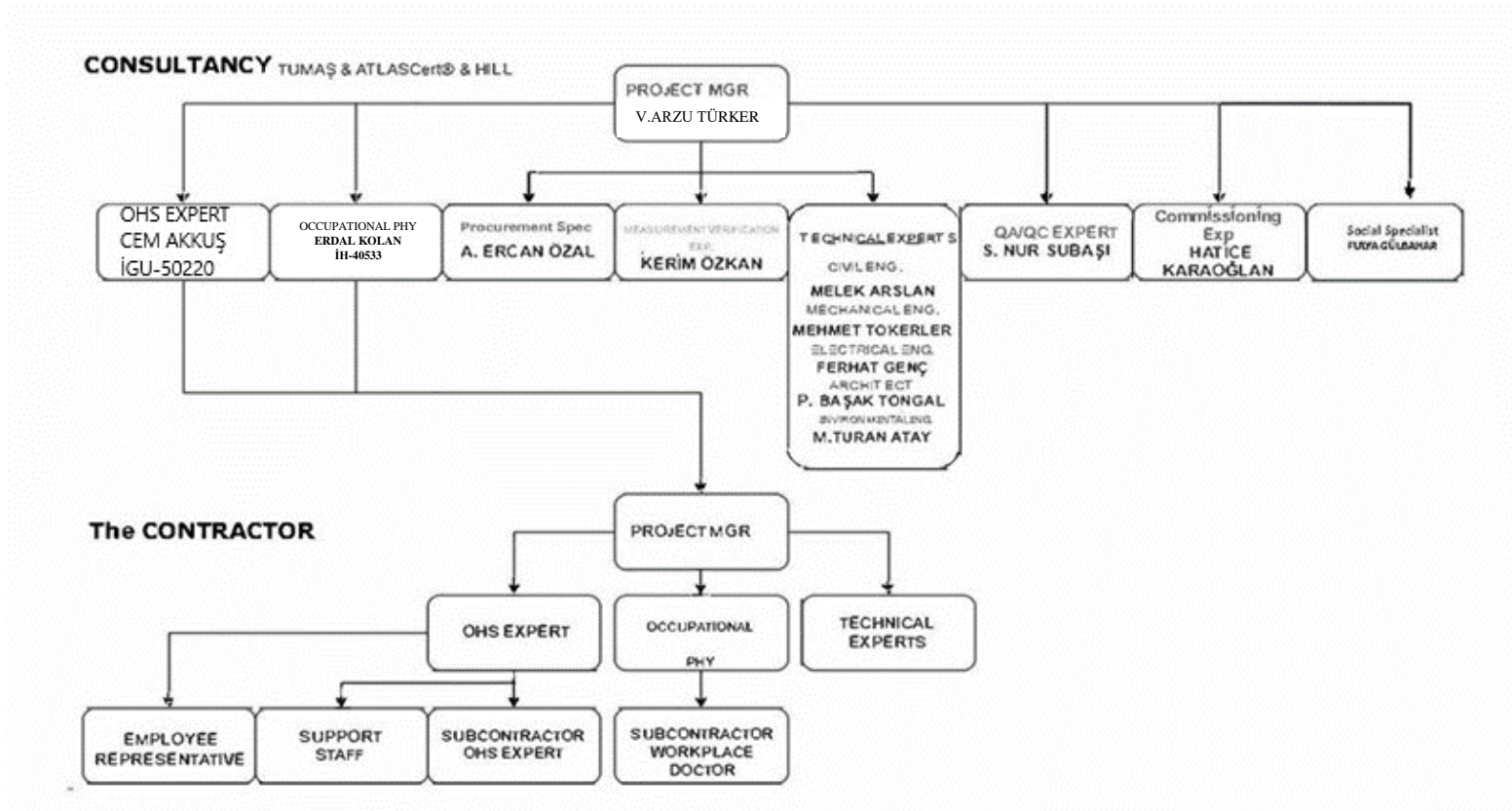

- The duties and responsibilities of the units specified in the organization chart are described under separate headings on the next page.

7.1. Consultant

7.1.1. Duties of the Project Manager

The Project Manager has been appointed as the employer's representative, limited to this project. In this context, the employer has undertaken its duties.

In this framework;

1. Ensure the implementation of the Occupational Health and Safety Plan and compliance with legal regulations and best practices within the scope of the project.
2. Review and assess the construction methods and risk analyses prepared by the contractor, focusing on technical, administrative, and occupational safety aspects. If found inadequate⁴, provide reasons and monitor the revision process.
 - a) The construction methods and risk analyses prepared by the contractor should cover the entire project, including subcontractor activities.
 - b) Ensure that the contractor and subcontractors' control and oversee the following aspects regarding risks and precautions.
 - i. Properly informing all employees.
 - ii. Providing the necessary resources (equipment, materials, workforce).
 - iii. Ensuring compliance with all rules by all managers and employees.
3. Ensure the suitability and sufficiency of risk assessments through field inspections.
 - a) Any non-compliance identified during these inspections will be recorded as corrective actions. Ensure that identified non-compliances are rectified adequately and within the specified timeframe.
 - b) Identified non-compliances or corrective actions may necessitate a revision of risk analyses. In such cases, ensure that risk analyses are reissued with the revision number, date, and justifications, following the necessary approval processes.
4. Ensure that employees obtain periodic health reports and are monitored based on the tasks they perform. Do not allow those who cannot provide reports indicating the suitability of their health for their assigned tasks to work.
5. Ensure that the educational status of employees is verified, and that they have received training in compliance with legal requirements. Do not allow those who cannot prove they have received appropriate training to work.
6. Ensure that employees' vocational qualifications are checked and do not allow those who cannot prove appropriate vocational competence within the scope of their duties to work.
7. Ensure the identification, procurement, and proper delivery of necessary Personal Protective Equipment (PPE) to employees.
8. Determine, procure, and properly install safety equipment (protective nets, guardrails, lifelines, etc.) required to be present at the work sites.
9. Ensure that work accidents are reported in accordance with Article 14 of the Occupational Health and Safety Law No. 6331.

⁴ It should be evaluated within the scope of Corrective Action (detection dates, justifications, corrective action suggestions, deadlines, etc.) and recorded.

10. Fulfill the employer's defined responsibilities within the framework of Law No. 6331 on Occupational Health and Safety.

- a) In order to achieve this, the Project Manager must comply with the up-to-date law no. 6331 and other relevant regulations; It should be reviewed together with the OHS Specialist and Workplace Physician.

7.1.2. Duties of the OHS Specialist

The duties of OHS Experts specified in Article 9 of the REGULATION ON DUTIES, AUTHORITIES, RESPONSIBILITIES AND TRAINING OF OCCUPATIONAL SAFETY EXPERTS (*Official Gazette Date: 29.12.2012 Official Gazette Number: 28512*) are given below. He/she will manage occupational health and safety activities in accordance with the duties given below.

1. Guidance;

- a) To ensure that work is planned, organized, and implemented in accordance with occupational health and safety legislation and general occupational safety rules, including the condition, maintenance, selection of design, machinery, and other equipment used in the workplace, as well as the selection, procurement, use, maintenance, storage, and testing of personal protective equipment, and to make recommendations to the employer regarding work carried out and changes to be made in the workplace.
- b) To inform the employer in writing about the precautions that need to be taken in terms of occupational health and safety.
- c) To inform the employer in writing about the precautions that need to be taken in terms of occupational health and safety.
- d) To conduct investigations into the causes of workplace accidents and occupational diseases and make recommendations to the employer on measures to prevent their recurrence.

2. Risk Assessment;

Participating in the work related to occupational health and safety risk assessment and its implementation, making recommendations to the employer regarding the health and safety measures to be taken as a result of the risk assessment, and monitoring its implementation.

3. Workplace Surveillance;

- a) Supervising the workplace, planning and monitoring the periodic maintenance, inspections, and measurements required by occupational health and safety legislation, and ensuring their implementation.
- b) Participating in efforts to prevent accidents, fires, or explosions in the workplace, making recommendations to the employer in this regard, monitoring the implementation of practices; participating in the preparation of emergency plans for natural disasters, accidents, fires, or explosions, ensuring that periodic training and drills related to this issue are conducted, and monitoring and controlling compliance with the emergency plan.

4. Training, Information, and Records;

- a) Planning the occupational health and safety training of employees in accordance with the relevant legislation, presenting it to the employer for approval, and implementing or supervising the implementation.
- b) Recording the results of occupational health and safety activities related to the workplace and workplace surveillance.

- c) Organizing informative activities for employees, presenting them to the employer for approval, and controlling their implementation.
 - d) Preparing occupational health and safety instructions and work permit procedures for use in necessary locations, presenting them to the employer for approval, and controlling their implementation.
5. Collaboration with Relevant Departments;
- a) Conduct assessments, along with the occupational physician, related to workplace accidents and occupational diseases, prepare necessary preventive action plans to prevent the recurrence of accidents, and monitor the implementation.
 - b) Prepare the annual work plan for occupational health and safety activities to be carried out in the following year in collaboration with the occupational physician.
 - c) Collaborate with the occupational health and safety committee of which they are a member if available,
 - d) Provide support to employee representatives and support staff and collaborate with these individuals.

Within this framework;

1. Examine construction methods and risk analyses, prepare a report regarding their suitability. Transmit the prepared report to the Project Manager and the Contractor's Project Manager.
2. During the project preparation phase, prepare weekly monitoring reports and present them to the Project Implementation Unit.
3. During the project implementation phase, ensure the preparation of monthly Occupational Health and Safety (İSG) reports by the Contractor and submit the reports to the administration in the specified format.
4. Obtaining and checking the periodic inspection reports of work machinery. (Maximum inspection frequency in the regulation is 1 year.).
5. Ensuring the delivery of personal protective equipment specified in the risk analysis to all employees. (Checking the PPE delivery records, questioning the adequacy and proper use of the equipment during field inspections.)
6. Verifying the authorization and appointments of the Contractor's and Subcontractor's Occupational Health and Safety Specialist and Workplace Doctor.
7. Improving this document and updating it based on on-site findings.
8. Checking employee personnel files.
9. Checking records and certificates related to employees' past OHS training (maximum period of 1 year).
10. Attending weekly and monthly OHS meetings and reporting them to the management.
11. Verifying the professional competence certificates of the employees.
12. Reviewing work reports from the perspective of occupational health and safety, assessing any work or equipment that may violate occupational health and safety rules.
13. Conducting daily field inspections, assessing any work or equipment that may violate occupational health and safety rules. Evaluating the adequacy of risk analyses and established measures on-site.
14. Reviewing reports of on-site inspections conducted by the Contractor and Subcontractor OHS specialists. Monitoring and controlling identified non-compliances.

15. Reviewing records of current training provided by the Contractor and Subcontractor OHS Specialists (Risk Analysis, Toolbox, etc.). Examining their adequacy (duration, content).
16. Communicating with Employee Representatives, requesting feedback. Reporting issues raised by Employee Representatives to the Project Coordinator, determining necessary actions, and implementing them.
17. Obtain accident reports prepared by Contractor and Subcontractor OHS Specialists, review them at the content and incident sequence levels, and check if notifications were made in compliance with legal requirements.
18. Checking suggestion and complaint boxes. Evaluating feedback received through printed or digital means within the framework of OHS (Occupational Health and Safety), ensuring the information of those providing feedback, assessing requests, and determining necessary actions. (Collaboration with the Social Specialist will be involved in this process).
19. Providing timely information to the Project Manager regarding field observations, feedback, information obtained from the Contractor and Subcontractor OHS specialists, and workplace accidents without delay.
20. .

7.1.3. Duties of Occupational Physicians

The duties of occupational physicians are outlined below, as specified in THE REGULATION ON THE DUTIES, POWERS, RESPONSIBILITIES, AND TRAINING OF OCCUPATIONAL PHYSICIANS AND OTHER HEALTH PERSONNEL (*Official Gazette Date: 20.07.2013 Official Gazette Number: 28713*) Article 9;

1. Guidance;
 - a) Provide guidance to the employer regarding the health monitoring of employees and the surveillance of the work environment within the scope of occupational health and safety services.
 - b) Offer recommendations to the employer for ensuring that the design and organization of the workplace, including the use of substances, comply with occupational health and safety legislation and general workplace safety rules, particularly in relation to the planning, organization, and implementation of work and the selection of personal protective equipment.
 - c) Advise the employer on activities aimed at improving the health of employees in the workplace.
 - d) Participate in investigations related to occupational health and safety, as well as conduct research to ensure the harmony between work and the capabilities of employees, considering ergonomic and psychosocial risks in the workplace, and protect employees from stress factors in the work environment. Take into account the results of these investigations in guidance activities.
 - e) Continuously monitor and inspect the general hygiene conditions of workplace buildings and facilities, including cafeterias, dining halls, dormitories, changing rooms, showers, and toilets, and provide recommendations for ensuring that employees receive the necessary nutrition and access to suitable drinking water based on the requirements of the work being performed.
 - f) Investigate the causes of workplace accidents and occupational diseases and make recommendations to the employer on measures to prevent their recurrence.

- g) Conduct investigations on the incidents in the workplace that, while not resulting in death or injury, have the potential to cause harm to employees, equipment, or the workplace, and provide recommendations to the employer.
 - h) Communicate in writing to the employer the precautions and measures that need to be taken in the field of occupational health and safety.
2. Risk Assessment;
- Participate in activities related to occupational health and safety risk assessment and its implementation. Provide recommendations to the employer regarding health and safety measures that need to be taken based on the results of the risk assessment and ensure their follow-up.
3. Health Surveillance;
- a) Inform and obtain the consent of employees regarding pre-employment and periodic medical examinations and tests conducted as part of health surveillance.
 - b) Conduct health surveillance for employees, including those working night shifts.
 - c) Repeat periodic medical examinations annually (unless otherwise recommended by the occupational health physician).
 - d) Determine if there is a correlation between health-related work absences and potential health hazards in the workplace. Plan for environmental measurements, if necessary, seek the employer's approval, and evaluate the results in terms of employee health.
 - e) Conduct return-to-work medical examinations for employees who have been absent from work due to health reasons. Recommend suitable tasks for those whose previous roles may pose health risks based on their current health status and seek the employer's approval.
 - f) Take measures to control infectious diseases, prevent their spread, and conduct immunization campaigns. Provide necessary hygiene training, ensure medical examinations and tests are performed, and promote a healthy work environment.
 - g) Maintain records of health surveillance activities in the workplace. Collaborate with the occupational health and safety specialist to assess workplace accidents and occupational diseases. Prepare preventive action plans to prevent the recurrence of accidents and submit an annual work plan, including these topics, to the employer for approval. Monitor the implementation of these plans and prepare an annual evaluation report.
 - h) Check whether health reports demonstrating the fitness of employees sent temporarily to the workplace by another employer or subcontracted workers are still valid.
4. Training, Information, and Records;
- a) Plan and conduct employee occupational health and safety training in accordance with relevant regulations. Present these plans to the employer for approval and ensure their implementation or oversee the training programs.
 - b) Organize and provide training for first aid and emergency response services at the workplace, following the requirements of the relevant regulations.
 - c) Provide training to managers, occupational health and safety committee members (if applicable), and employees on general health, occupational health and safety, hygiene, the hazards of substance abuse, personal protective equipment, and collective protection methods. Ensure the continuity of these training programs.
 - d) Inform employees about workplace risks, health surveillance, and pre-employment and periodic medical examinations.

- e) Collaborate with the occupational health and safety specialist to prepare an annual evaluation report documenting the results of occupational health and safety efforts and health surveillance.
 - f) Report information related to occupational health and safety topics determined by the Ministry to the General Directorate through the Occupational Health and Safety Automation System (ISG CLERK).
5. Collaboration with Relevant Departments;
- a) Recommend, based on the results of health surveillance, the conduct of necessary measurements within the scope of workplace monitoring in collaboration with the occupational health and safety specialist, and evaluate the measurement results.
 - b) Collaborate with the occupational health and safety committee (if applicable) to work on providing information and training on occupational health and safety topics in the workplace.
 - c) Collaborate with relevant parties to provide information and education on workplace health and safety.
 - d) Participate in the development of programs aimed at improving existing practices, analyzing occupational accidents and occupational diseases, evaluating new technologies and equipment from a health perspective, and making recommendations for the prevention of accidents.
 - e) Collaborate with authorized hospitals for the preparation of health board reports related to occupational diseases according to the Regulation on the Rate of Incapacity to Work and Occupational Accidents and cooperate with relevant units for the rehabilitation of employees who have suffered workplace accidents or contracted occupational diseases.
 - f) Contribute to the preparation of occupational health and safety instructions and work permit procedures for use in necessary areas.
 - g) Provide support to employee representatives and support personnel in their activities and collaborate with these individuals.

Within this framework;

1. Verify the authorization and appointments of occupational health physicians for contractors and subcontractors.
2. Develop and update this document in line with field findings,
3. Support the risk analysis control process by examining construction methods and data related to work areas provided by subcontractors and other specialists.
4. Verify employee personnel files.
5. Review employees' periodic health reports.
6. Review weekly work reports from an occupational health perspective and evaluate any inappropriate work or equipment presence.
7. Review reports of field inspections conducted by occupational health physicians from contractors and subcontractors. Track and control identified non-conformities.
8. Review records of current training provided by occupational health physicians from contractors and subcontractors. Verify their appropriateness in terms of duration and content.

9. Communicate with employee representatives, request feedback, report issues to the Social Specialist and Project Manager, determine necessary actions for occupational health, and implement them.
10. Obtain and review occupational disease reports prepared by occupational health physicians from contractors and subcontractors. Ensure compliance with legal requirements for reporting.
11. Evaluate feedback obtained through the suggestion and complaint system in terms of occupational health, based on requests from the Social Specialist, and determine necessary actions.
12. Inform the Project Manager without delay about field observations, feedback, information obtained from contractors and subcontractor occupational health physicians, and workplace accidents.

7.1.4. OHS Duties of Technical Experts

The Technical Expertise Unit, composed of disciplines in Civil Engineering, Mechanical Engineering, and Electrical Engineering, will perform the following tasks in OHS processes:

1. Inform OHS experts about the technical details and processes of the work.
2. Ensure that the work they oversee is conducted in a way that protects the health and safety of employees.
3. Examine the construction methods prepared by the contractor and evaluate their adequacy.
4. Technically evaluate the aspects mentioned in risk analyses (hazards, risks, and measures) and make evaluate their suitability.
5. If deemed necessary by the OHS expert, participate in the work permit system, respond to inquiries from the OHS expert, and assess and query documents transmitted by the OHS expert within this framework.
6. Evaluate, from a technical perspective, OHS training content provided by the contractor. Make evaluate its adequacy (e.g., LOTO systems, scaffold installation and usage, etc.)

7.1.5. OHS Duties of the Social Specialist

1. Receive and compile printed suggestion and complaint forms submitted to the OHS expert.
2. Review feedback obtained within the framework of the suggestion and complaint system. If necessary, involve the OHS expert and workplace physician in the feedback evaluation process.
3. Maintain contact with Employee Representatives and support the establishment of a healthy and strong communication between the OHS expert, workplace physician, and Employee Representatives.

7.1.6. Duties of Support Staff

Carry out the tasks requested by the Occupational Health and Safety (OHS) Specialist and Workplace Physician.

7.2 Contractor Company

7.2.1. Employer and Employer Representative Duties

The Project Manager has been designated as the employer representative for this project, and as such, they are responsible for the following tasks.

1. As the employer, ensure the fulfillment of all duties specified within the Occupational Health and Safety Law No. 6331.
2. Ensure monitoring requirements, frequencies, responsibilities for the Contractor mentioned on the Table 28 OHS Monitoring Plan
3. Ensure that this document, as provided by the Consultant OHS Specialist, is communicated to all relevant units and understood.
4. Ensure that the OHSP, construction methods and risk analysis are prepared and presented to the Consultant before field work begins.
5. Promptly provide the Consultant OHS Specialist and Workplace Physician with the requested information and documents.
6. Promptly provide the requested information and documents to the Consultant Social Worker.
7. Establish and ensure the effectiveness of the recommendation and complaint system provided by the Consultant Social Worker.
8. Attend meetings and discussions requested by the Consultant Project Manager.
9. Monitor and control the performance of the appointed OHS Specialist and Workplace Physician.
10. Review and fulfill requests made by the Consultant OHS Specialist regarding the performance of the OHS Specialist and Workplace Physician (e.g., changes, warnings, etc.)

7.2.2. Duties of the OHS Specialist

1. Fulfill all responsibilities as specified in the REGULATION ON THE DUTIES, AUTHORITIES, RESPONSIBILITIES, AND TRAINING OF OHS SPECIALISTS in full compliance with the regulation.
2. Ensure the preparation of the contractor OHSP for project works in line with this OHSP, creation of a risk analysis within the framework of the construction method and submit it to the Consultant OHS Specialist before fieldwork begins.
3. Provide records and certificates of past OHS training for employees to the Consultant OHS Specialist.
4. Provide current training to employees based on this document and risk analysis within the scope of the project. Keep training records and submit them to the Consultant OHS Specialist.
5. Plan and implement additional training requested by the Consultant OHS Specialist. Keep records of training and provide them to the Consultant OHS Specialist.
6. Submit employees' Occupational Competency Certificates to the Consultant OHS Specialist.
7. Inform all employees about the recommendation and complaint system implemented specifically for this project.
8. Submit machine periodic inspection reports to the Consultant OHS Specialist.

9. Provide the lists of Personal Protective Equipment (PPE) (standard, quantity, etc.) and delivery receipts to the Consultant OHS Specialist.
10. Participate in field inspections conducted by the Consultant OHS Specialist and have the requested information and documents readily available.
11. Submit records of work accidents to the Consultant OHS Specialist.
12. Implement corrective actions communicated by the Consultant and inform the Consultant OHS Specialist and/or Workplace Physician regarding the process.
13. Plan, attend, and report on weekly and monthly OHS meetings.
14. .

7.2.3. Duties of Subcontractor Workplace Physicians

1. Fulfill all responsibilities as specified in the REGULATION ON THE DUTIES, AUTHORITIES, RESPONSIBILITIES, AND TRAINING OF WORKPLACE PHYSICIANS in full compliance with the regulation.
2. Ensure the creation of a risk analysis within the framework of the construction method.
3. Submit employees' periodic occupational health reports to the Consultant Workplace Physician.
4. Provide records and certificates of past occupational health training for employees to the Consultant Workplace Physician.
5. Plan and implement additional training requested by the Consultant Workplace Physician. Keep records of training and provide them to the Consultant Workplace Physician.
6. Submit records of occupational diseases to the Consultant Workplace Physician.
7. .

7.2.4. Technical Experts' OHS Duties

The Technical Expertise Unit consisting of Civil Engineering, Mechanical Engineering, and Electrical Engineering disciplines will perform the following tasks within OHS Processes:

1. Inform OHS Specialists about the technical details and processes of the work.
2. Ensure that the work being carried out is done in a way that protects the health and safety of employees.
3. Develop construction methods and communicate them to the OHS Specialist.
4. Technically evaluate the aspects specified in risk analyses (hazards, risks, and measures) and make judgments regarding their appropriateness.
5. Participate in the work permit system if deemed necessary by the OHS Specialist, answer questions posed by the OHS Specialist, and assess and query documents provided by the OHS Specialist.
6. Ensure the technical improvement of OHS training content (e.g., LOTO system, scaffold installation and usage, etc.)

7.2.5. Employee Representative Duties

1. Fulfill all responsibilities and duties as specified in the 6331 Occupational Health And Safety Law (Official Gazette Date: 30.06.2012 Official Gazette Number: 28339).
2. Participate in risk analysis studies within the framework of the construction method.

3. Support the OHS Specialist in implementing the feedback from other employees through the project-specific Suggestions & Complaints system, and provide information to employees about this.
4. Establish strong communication with the Consultant OHS Specialist, Workplace Physician, and Social Specialist, and provide information about the general requests and conditions of employees.
5. Report situations related to avoiding work to the Consultant OHS Specialist without delay.
6. Inform the Consultant Social Specialist of any situations that may negatively affect the effectiveness of the suggestion and grievance system.

7.2.6. Support Personnel Duties:

Complete tasks requested by the OHS Specialist and Workplace Physician. Two occupational health and safety workers will perform regular duties in the field.

8. Management of Works

General Work Program and Cross Interaction

The general work program is presented below for your attention. This program is not final but has been created for the purpose of identifying cross-interaction risks during the work. A detailed work program/plan should be created by the contractor and submitted to the consultant.

Table8: General Work Program

	1				2				3				4				5				6			
	01	02	03	04	01	02	03	04	01	02	03	04	01	02	03	04	01	02	03	04	01	02	03	04
STRUCTURAL REINFORCEMENT																								
WALL DEMOLITION & DISMANTLING																								
ELECTRICAL AND MECHANICAL SYSTEM																								
SUBSTRUCTURE CONCRETE DEMOLITION																								
EPOXY ANCHORS AND TESTING																								
NEW REINFORCEMENT INSTALLATION																								
FORMWORK AND CONCRETE CASTING																								
FINISHING WORKS																								
WALL CONSTRUCTION																								
PLASTERING																								
PAINTING																								
FLOORING																								
ELECTRICAL& MECHANICAL&ENERGY EF.																								
CONCRETE PIPE INSTALLATION																								
ELECTRICAL INSTALLATION																								
MECHANICAL INSTALLATION																								
AUTOMATION																								
FACADE INSULATION																								
SOLAR PANEL INSTALLATION																								
TESTING & INSPECTION																								

8.1 Working Methods

The following general descriptions of the construction process are provided to guide the contractor in preparing detailed construction methods and risk analysis studies. The contractor must prepare the construction method and risk analysis for each new project and submit it for approval by the consultant. Work may commence only after obtaining approval.

8.1.1 Structural Reinforcement

1. The Current Situation Performance Report, prepared in line with the structural surveys and findings, provides objective evidence that the structure needs strengthening. The infrastructure construction around the buildings will be carried out using traditional methods, including land measurement, route excavations, adjustment of route elevations, laying of scaffolds, and the creation of chimneys. The connection of the superstructure exiting the building to the new chimneys will be performed. The major points to be taken into consideration are listed below.
 - The use of heavy machinery is crucial. Excavation work involves the use of excavators, loaders, and trucks. It is essential to check the periodic inspection reports and user competency certificates (operator license, Class C driver's license) for these devices before starting work.
 - In areas where the underground natural gas pipeline facility is involved, the Provider Natural Gas Company is responsible for ensuring a feasible environment by performing necessary operations before the start of Phase II (Construction Phase) of the projects. The implementation of the project must be carried out under the supervision of Infrastructure Construction Control Personnel Level 4 (National Vocational Qualifications Institution (VQI) Law No. 5544 - 12UY0042-4).
 - (*The Natural Gas Pipeline process in question will be completely ready, all controls and tests will be carried out by the **Service Provider Local Distribution Company** before the Site Transfer takes place in order to create the necessary environment and will ensure delivery as specified in the projects. The Property Owner must apply for the construction of the facilities in question in accordance with the relevant legislation. For this reason, it is **ABSOLUTELY** impossible for neither the Consultant Company nor the Contractor to intervene in these natural gas pipelines.)
2. In the implementation of the superstructure reinforcement, dismantling processes will be carried out from upper floors to lower floors as a priority. Reinforcement curtains and column jackets on the designated axes will be demolished, starting from the top floor and using a hammer and breaker. Before the demolition of walls, items such as doors, windows, fixtures, countertops, electrical, and mechanical installations that may be damaged should be removed and protected. The major points to be considered are listed below.
 - Consideration should be given to the potential danger of the elements to be demolished containing electrical wiring. Prioritizing the interruption of power in the area; the electrical needs of tools such as breakers, drills, etc., should be supplied from alternative sources. Components such as distribution boxes, outlets, lighting element lines, switches, etc., should be inspected before demolition, and it should be verified that there is no power. During this process, the use of inspection items alone is not sufficient. Control devices such as a phase voltage detector should be used at a minimum. Functional checks of these testing devices should be performed daily (using working outlets).

Figure 5 Phase Detector Sample Image



- All electric hand tools must have undergone Portable Appliance Testing (PAT). PAT test reports will be requested and checked before work commences. During field inspections, the presence of PAT inspection and approval labels on electrical devices will be verified. Devices and equipment without compliance labels are not permitted for use. (Extension cables are also included in this scope.)

Figure 6 Pat Test Label Sample Image

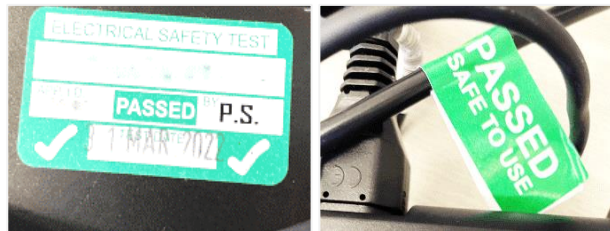

- Care must be taken to prevent damage to electrical extension cables and to ensure that these cables do not come into contact with water. Extension cables and other power cables for electrical devices will be checked daily. The use of damaged cables is not allowed.
- During demolition, both sides of the walls must be inspected, and necessary precautions must be taken to prevent workers from being trapped under debris (restricting access, observing the affected areas of walls to be demolished, using warning signs and caution labels, etc.).
- In wall demolitions affecting the exterior of the building, impact zones must be identified, and entry to these areas must be prohibited.
- Prior to wall demolition, reinforced areas must be marked. It is essential to ensure that these reinforced elements (load-bearing) do not incur damage. The demolition team will be reminded of this on a daily basis.
- To prevent damage to the floor during demolition work, walls must be broken into pieces and brought down in a controlled manner. Techniques to avoid demolishing walls in their entirety should be communicated to the workers. Protective covers of appropriate thickness should be used for surfaces that need to be preserved.
- Employees involved in the transportation of debris must be informed about manual handling procedures. It is prohibited to throw debris outside from a height in an uncontrolled manner. The method for removing debris will be determined and communicated by the contracting company.
- During the demolition process, employees must use dust masks and protective goggles to protect themselves from dust.

- To protect workers from noise during the demolition process, the use of earplugs or earmuffs is mandatory.
 - In the demolition process, workers must use protective goggles to shield themselves from flying debris.
3. After the dismantling process, it is necessary to break the substructure concrete and excavate the foundation fill to open up the surroundings of the reinforcement elements for their connection to the foundations. These breaking and excavation operations will be carried out manually (with the help of a breaker and a hammer) and/or with small machines that can enter the structure (such as a bobcat, etc.)

Major points to consider are listed below.

- During maneuvers with heavy machinery in confined spaces, responsible operators should be informed in advance to prevent damage to walls and reinforced components that need protection. Construction methods for the use of such machinery inside buildings should be communicated to the consultant beforehand. (This document should specify whether there is a risk of permanent damage in terms of moving the machinery to the working area, demolishing walls to bring it inside the building, and internal maneuvers during work.)
 - Warning tapes should be placed around excavated areas. If work is carried out at night, these tapes should have reflective properties.
4. After the completion of excavation processes, anchor rods are driven into the existing columns, beams, and foundations. Anchor holes are drilled into the existing elements using drilling drills according to the dimensions specified in the detailed projects. The process involves cleaning the hole with a compressed air compressor, injecting epoxy adhesive into the hole, and inserting the pre-prepared anchor rod (made of normal ribbed construction iron) into the hole.

Figure 7: Installing Anchor Rods Sample Image



The major points that need to be considered are listed below:

- Anchor rods with exposed ends carry a serious risk of injury or even death in the event of a fall. Areas with such risks should be surrounded by warning labels as long as they pose a risk, and workers should be alerted. (Care must be taken to ensure that the tips of anchor rods are not sharp or cutting.) Especially in areas with a risk of falling, warning tapes should surround them according to the principle of the impact zone.
 - All electrical hand tools must have undergone Portable Appliance Testing (PAT). PAT test reports will be requested and checked before work begins. During field inspections, the presence of PAT control and approval labels on electrical devices will be verified. Devices and equipment without compliance labels are not allowed to be used. (Extension cables are also included in this scope.)
 - Care must be taken to ensure that electrical extension cables are not damaged, and these cables should not come into contact with water. Extension cables and other electrical power cables will be inspected daily. Damaged cables are not allowed to be used.
 - There is a risk of anchor rods falling from the building to the ground. Workers should consider this risk during the stacking and installation of these ribbed irons. The use of helmets within the work area is a minimum requirement for all workers.
 - Anchor rods are likely to be rusty. Therefore, workers must use appropriate types of protective gloves. In addition, all workers must have received tetanus vaccinations. (During occupational health and safety training, the occupational health physician should inform employees about infections caused by rusty metals and tetanus.)
 - Compressors used for hole cleaning must be inspected by competent mechanical engineers, and their compliance must be verified.
 - MSDS (Material Safety Data Sheet) for epoxy adhesives must be checked by occupational health physicians, and employees must be informed (regarding volatile properties, eye contact, etc.).
 - The necessity of eye wash stations against dust and chemical usage should be determined by the occupational health physician.
 - Personnel working with reinforcement bars must hold the Level 3 Reinforcement Steelworker (11UY0012-3) certificate.
5. Carrying out the installation of strengthening element reinforcement along with anchor manufacturing.
- The important points to be considered are listed below:
 - During the placement of reinforcement metals, the risks of piercing and cutting should be taken into account. The ends of reinforcement metals should not be left freely in a way that poses a danger.
 - Ends of reinforcement metals, which carry the risk of piercing and may be difficult to see due to reasons such as level differences, should be covered with plastic wedges and clearly marked with appropriate warning signs.

- Due to the likely rustiness of reinforcement bars, workers should use the appropriate type of protective gloves. Additionally, all workers should have up-to-date tetanus vaccinations. Occupational health physicians should inform employees about infections caused by rusty metals and tetanus during workplace health and safety training.
 - If iron bending and cutting machines are used in the shaping of reinforcement bars, these machines must have undergone Portable Appliance Testing (PAT). PAT test reports will be requested and checked before work begins. During field inspections, the presence of PAT control and approval labels on electrical devices will be verified. Devices and equipment without compliance labels are not allowed to be used. (Extension cables are also included in this scope.)
 - Personnel handling reinforcement bars must have the Level 3 Reinforcement Steelworker (11UY0012-3) certificate.
6. After the testing and reinforcement samples are taken over by the control organization, plywood molds are closed, and "self-compacting concrete" (fine-aggregate, superplasticizer-enhanced concrete) is poured into the mold through a funnel made from a hole opened from the upper floor slab or a mold known as a bird's beak. The process of pouring concrete is carried out using a transit mixer and a concrete pump. In areas where the pump cannot reach within the existing structure, if necessary, mobile pipes (corrugated pipes, etc.) or manual transport of concrete may be employed. After pouring the concrete for the reinforcement element of one floor and allowing a minimum of 2 days to pass, the concrete for the next floor should be poured. Gaps that may occur due to the inability of concrete to reach between existing elements and the new reinforcement element are filled with high-strength, polymer-fiber-reinforced repair mortars. The major points to be considered at this stage are listed below.
- All electrical hand tools (mobile concrete mixers, vibrators, concrete pumps, etc.) must have undergone Portable Appliance Testing (PAT). PAT test reports will be requested and checked before work begins. During site inspections, the presence of PAT control and approval labels on electrical devices will be verified. Devices and equipment without compliance labels are not allowed to be used. (Extension cables are also included in this scope.)
 - Care must be taken to prevent damage to electrical extension cables, and these cables must not come into contact with water. Extension cables and other power cables for electrical devices will be checked daily. The use of damaged cables is not permitted.
 - MSDS (Material Safety Data Sheet) for repair mortars and similar materials must be checked by occupational health physicians, and employees must be informed (inhalation, eye contact, etc.).
 - During the access of transit mixers to the working area, compliance with traffic action plan rules must be ensured. Access of unrelated employees to the vicinity of transit mixers should be prevented with warning tapes during parking and operation.
 - Personnel involved in formwork tasks must have Level 3 Wood Formwork Carpenter (11UY0011-3) certification.

- Personnel involved in concrete casting tasks must have Level 3 Concrete Worker (12UY0049-3) certification.
7. After the completion of the rough construction, repair works are initiated. The application of plaster, paint, insulation, etc., on the inner and outer surfaces of strengthening walls, leveling concrete and coating material arrangements on damaged floors, electrical and mechanical installations, and if necessary, door and window manufacturing are carried out to complete the reinforcement works. The major points to be considered at this stage are listed below:
- Necessary mobile, fixed temporary scaffolds, and precast steel and aluminum alloy component scaffolds, if required, must be designed and constructed in accordance with TS EN 12811-1 and TS EN 12810-2 standards in a manner that will not accidentally move or collapse, and the scaffold components must be designed to be safely transported, assembled, used, maintained, disassembled, and stacked. The materials used must meet the requirements given in TS EN 12810-1 and TS EN 12811-2 standards where design data is provided and must be robust and durable enough to withstand normal working conditions. It is mandatory for all personnel working on these scaffolds to have received working at heights training, and they must use full-body harnesses and fall prevention equipment.

Figure 8: Exterior Scaffolding Sample Image

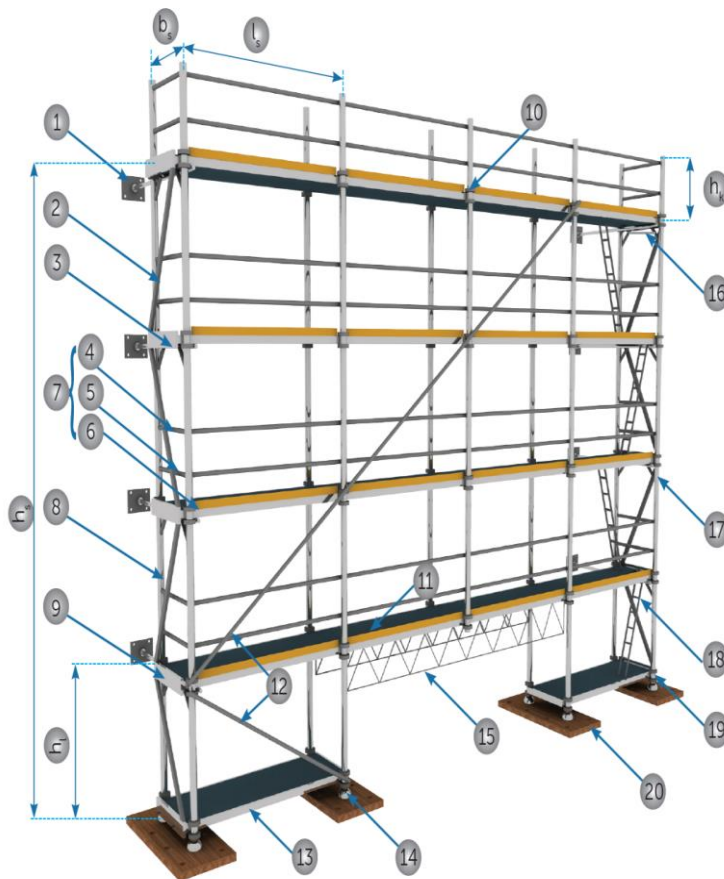

- hs: Scaffold Height
bs: Scaffold Outreach Width (From center to center of uprights)
ls: Scaffold Outreach Length (From center to center of uprights)
hl: Scaffold Storey Height
hk: Railing Height
- 1: Anchor
2: Vertical Plane Reinforcement (Transverse)
3: Node Point
4: Main Railing
5: Intermediate Railing
6: Toe Board
7: Side Protection
8: Upright
9: Transverse Intermediate Connection
10: Joint Element
11: Platform
12: Vertical Plane Reinforcement (Longitudinal)
13: Longitudinal Intermediate Connection
14: Base Plate
15: Cage Beam
16: Tie Element
17: Vertical Frame
18: Stair
19: Height-Adjustable Base Plate
20: Ground Fixing Base
- Note: The figure is for the introduction of scaffold components and does not show the conditions that need to be met.

- Personnel responsible for scaffold installation must have Scaffold Installation Level 3 (12UY0056-3) certification.
- Personnel working on electrical installations must have a minimum of Electrical Installer Level 3 (15UY0241-3) certification.
- Personnel assembling electrical panels and boards must have a minimum of Electrical Panel Assembler Level 3 (12UY0075-3) certification.
- Torque-controlled screwdrivers and tightening equipment should be used during the assembly of electrical panels/boards. Appropriate tightening forces should be predetermined based on the type of switchgear or the dimensions of screws and nuts and communicated to responsible personnel.
- Personnel involved in the mechanical installation process must have a minimum of Heating and Natural Gas Interior Plumbing Construction Staff Level 3 (11UY0031-3) certification.
- Personnel placing wall anchors must have a Wall Builder Level 3 (12UY0048-3) certification.
- Personnel conducting plastering work must have a Plasterer Level 3 (11UY0024-3) certification.
- Personnel conducting gypsum work must have a Gypsum Plaster Applicator Level 3 (12UY0055-3) certification.
- Personnel involved in ceramic tile work must have a Ceramic Tile Coverer Level 3 (12UY0051-3) certification.
- Personnel involved in painting work must have a Construction Painter Level 3 (11UY0023-3) certification.
- All personnel working in the field must have a minimum of Construction Worker Level 2 (16UY0253-2) certification.
- Material Safety Data Sheets (MSDS) for repair mortars, paints, etc., should be reviewed by occupational health physicians, and employees should be informed (inhalation, eye contact, etc.).
- All personnel carrying heavy loads must receive training in manual lifting and carrying.

Table 9: Building Strengthening & Superstructure Works Control Table

WORK TO DO:	Building Reinforcement & Superstructure Works
WORKING METHOD	
Technical Description and Requirements	
Construction Technique and Technology	
<ul style="list-style-type: none"> - It is explained in article 7 and its sub-articles under the sub-heading of Building Reinforcement and Superstructure Works. 	
Use of Work Equipment	
<ul style="list-style-type: none"> - EXCAVATOR LOADER - TRANSIT MIXER - TRUCK - ROCK BREAKER - SPIRAL - MORTAR MIXER - AIR COMPRESSOR - MOBILE CONCRETE MIXER - REBAR BENDING MACHINE - REBAR CUTTING MACHINE - CORDLESS / FIXED DRILL - CORDLESS SCREW/NUT DRIVER - PHASE VOLTAGE DETECTOR - MULTIMETER - TORQUE CONTROLLED SCREWDRIVER - TORQUE CONTROLLED FASTENING - INDOOR SCAFFOLDING (MOBILE / FIXED) - HAMMER & CHISEL - CORDLESS SCREWDRIVER - EXTENSION CABLE 	
Use of Chemical Substances:	
<ul style="list-style-type: none"> - CEMENT, PLASTER, EPOXY BINDER, PAINT, PAINT THINNER 	
Access to the Work Area:	
<ul style="list-style-type: none"> - Access road information is provided in the form of plans under the heading "Pre-construction Information & Site Plans.". <ul style="list-style-type: none"> • The maximum speed within the campus is limited to 20 km/h for trucks. • The maximum speed within the campus is limited to 20 km/h for mobile cranes. 	
Handling & Supply of Materials	
<ul style="list-style-type: none"> - Details regarding the removal, transportation, and unloading of consumables and related technical materials are specified and explained under the subheading "General Construction Site Rules." 	

PPE- GENERAL	Need for Trained Personnel
<ul style="list-style-type: none">• HELMET TS EN 397+A1• EARPLUG TS EN 352-2• PROTECTIVE GLASSES TS EN ISO 16321-3• GENERAL PURPOSE WORK GLOVES TS EN ISO 21420• WORK SHOES TS EN ISO 20347• HALF FACE MASK TS EN 140• FULL BODY SEAT BELT EN 361• ROPE BRAKING SYSTEM EN 353• SAFETY HOOK EN 362• FALL PREVENTION SAFETY ROPES EN 355	<ul style="list-style-type: none">• MECHANICAL ENGINEER• ELECTRICAL ENGINEER• CONSTRUCTION ENGINEER• ARCHITECT• SCAFFOLDING ELEMENT ELEMENT LEVEL 3 (12UY0056-3)• ELECTRICAL INSTALLER LEVEL 3 (15UY0241-3)• HEATING AND NATURAL INTERNAL SYSTEM. DO IT. THU. SLOPE. 3 (11UY0031-3)• Bricklayer LEVEL 3 (12UY0048-3)• PLASTER LEVEL 3 (11UY0024-3)• GYPSUM PLASTER APPLICANT LEVEL 3 (12UY0055-3)• CERAMIC TILE SEATER LEVEL 3 (12UY0051-3)• CONSTRUCTION PAINTER LEVEL 3 (11UY0023-3)• CONSTRUCTION WORKER LEVEL 2 (16UY0253-2)

Table 10: RISK ANALYSIS

WORK TO DO	SOURCE OF DANGER	RISKS	PRECAUTION
Natural Gas Line Interventions	Gas leak and explosion	<ul style="list-style-type: none"> ▪ Trauma ▪ Severe burn ▪ Loss of limb ▪ Death 	<ul style="list-style-type: none"> ▪ Prior to excavation works, it should be verified through İGDAŞ (Istanbul Gas Distribution Company) whether there is a natural gas pipeline in the relevant area. ▪ Natural gas pipelines must be shut down before any intervention and protected using the EKED system. ▪ Interventions in existing pipeline systems or the establishment of new pipelines will be conducted under the supervision of a Natural Gas Infrastructure Construction Control Personnel Level 4 (12UY0042-4). ▪ Personnel assigned to the task are required to wear work boots, protective goggles, a hard hat, a dust mask, and ear protection. ▪ The working areas will be delineated with safety tapes, and safety signs will be displayed to communicate potential risks.

WORK TO DO	SOURCE OF DANGER	RISKS	PRECAUTION
Wall Demolition	Being under heavy load Electric shock	<ul style="list-style-type: none"> ▪ Crush ▪ Trauma ▪ Electric shock 	<ul style="list-style-type: none"> ▪ The danger that the building elements to be demolished may contain electrical lines should be taken into consideration. Cutting off the energy of the area in question; crusher, driller etc. The electrical needs of the devices must be met from other lines. ▪ EKED rules should be activated in case of power outage. ▪ Before working, place sockets, switches, commutators, junction boxes, etc. on the wall. The presence of equipment should be checked and equipment and cable disassembly should be carried out in accordance with the instructions of the electrical engineer before demolition. ▪ Before demolition, it should be verified that there is no energy via the socket, junction box and switch using a phase voltage detector. ▪ All hammer drilling equipment to be used in crushing must pass the PAT test and be confirmed to be electrically suitable. ▪ Necessary care must be taken to ensure that electrical extension cables are not damaged and that the cables do not come into contact with water. Extension cords and other electrical appliance power cords will be checked daily. The use of damaged cables is not allowed. ▪ Other sides of the walls to be demolished should be separated by a safety barrier and warning signs should be installed. ▪ Walls should not be demolished as a whole, but in pieces in a controlled manner. ▪ It is mandatory for the personnel on duty to wear work shoes, protective glasses, hard hat, dust mask and headphones.

WORK TO DO	SOURCE OF DANGER	RISKS	PRECAUTION
Wall Demolition	<ul style="list-style-type: none"> ▪ Heavy objects falling from height. ▪ Employees falling from height. 	<ul style="list-style-type: none"> ▪ Head and body traumas ▪ Death 	<ul style="list-style-type: none"> ▪ The building perimeter will be separated by security barriers and warning signs. ▪ High-risk areas where parts of the wall to be demolished will fall will be determined before the work and will be monitored by responsible personnel. ▪ Personnel involved in breaking the wall will use full body safety belts and fall arrest equipment. The equipment in question will be connected to lifelines that will be fixed to solid structures. (The personnel in question must receive training on working at height.) ▪ The demolished wall sections will be secured with temporary railings and warning tapes/signs until the new wall is installed. If night work is done, the tapes and signs in question must be reflective. ▪ It is mandatory for the personnel on duty to wear work shoes, protective glasses, hard hat, dust mask and headphones.
Opening the curtain and column sheath surroundings	<ul style="list-style-type: none"> ▪ Construction Machinery 	<ul style="list-style-type: none"> ▪ Injury due to impact during work machine manoeuvre. ▪ Extremities being pinched or cut during work machine adjustment and parts replacement. 	<ul style="list-style-type: none"> ▪ Work machine suitability should be verified with a periodic inspection report. ▪ Before operating the work machine, it should be visually inspected by the operator and the presence of a physical defect should be evaluated. ▪ Work machines should be checked functionally by the operator before each work. (reversing warning siren, warning/warning lights, etc.) ▪ The work machine can only be used by an authorized Operator. Operator professional suitability documents must be checked and verified. ▪ Other than authorized personnel and experts (Operator, Mechanical Engineer, etc.) cannot be allowed to intervene in the work machine. ▪ The work machine working area will be separated by safety strips and it should be stated with safety signs that it is forbidden to approach the work machine. ▪ It is mandatory for the personnel on duty to wear work shoes, protective glasses, hard hat, dust mask and headphones.

WORK TO DO	SOURCE OF DANGER	RISKS	PRECAUTION
Opening the curtain and column sheath surroundings	Hole	<ul style="list-style-type: none"> ▪ Injury due to falling into a hole. 	<ul style="list-style-type: none"> ▪ Warning tapes and signs should be installed around the excavated areas. If night work is done, the tapes and signs in question must be reflective.
Nailing anchor rods to existing columns, beams and foundations	Rusty metal Sharp, Pointed parts Power tool use	<ul style="list-style-type: none"> ▪ Severe trauma due to cutting, stinging ▪ Tetanus ▪ Respiratory disorders ▪ Burr/small pieces getting into the eyes. <p>Electric shock</p>	<ul style="list-style-type: none"> ▪ It is essential that all electrical equipment used in drilling and cutting reinforcement be subjected to PAT testing and verified to be electrically safe. ▪ Extension cables and device supply cables must be physically protected. Cables should not be left lying on the ground, and wheelbarrows and workers should not be allowed to pass over them. Cables should not be allowed to remain in puddles of water. ▪ Before use, electrical equipment should be visually inspected and devices with physical defects should be excluded from use. ▪ Areas where anchor rods are installed should be posted with warning tapes and signs. If night work is done, the tapes and signs in question must be reflective. ▪ Employees must have had their tetanus vaccination. (The Workplace Physician must inform employees about infections and tetanus caused by rusty metals during training.) ▪ All employees must use the appropriate type of protective gloves. ▪ The necessity of eye wash despite the use of powder and chemicals should be determined by the workplace physician. ▪ Personnel who will process reinforcing bars must have the Reinforced Concrete Blacksmith Level 3 (11UY0012-3) certificate. ▪ Sharp, pointed ends should be chamfered with the appropriate type of cutter or spiral. A rubber buffer should be installed on sharp, pointed ends that cannot be corrected. ▪ It is mandatory for the personnel on duty to wear work shoes, protective glasses, hard hat, dust mask and headphones.

WORK TO DO	SOURCE OF DANGER	RISKS	PRECAUTION
Nailing anchor rods to existing columns, beams and foundations	Epoxy adhesives	<ul style="list-style-type: none"> ▪ Disorders due to chemical contact. 	<ul style="list-style-type: none"> ▪ MSDS of epoxy adhesives should be checked by workplace physicians and employees should be informed (volatile properties, eye contact, etc.). ▪ The necessity of eyewash despite the use of powder and chemicals should be determined by the workplace physician.
Laying reinforcement element reinforcement	metal, cutting, bending rusty metal Sharp, pointed parts Power tool use	<ul style="list-style-type: none"> ▪ Severe trauma due to cutting, stinging ▪ Limb compression ▪ Tetanus ▪ Respiratory disorders ▪ Burr/small pieces getting into the eyes. <p>Electric shock</p>	<ul style="list-style-type: none"> ▪ Personnel who will process reinforcing bars must have the Reinforced Concrete Blacksmith Level 3 (11UY0012-3) certificate. It is essential for cutting and bending reinforcement and all electrical equipment to be subjected to PAT testing and to verify that it is electrically safe. ▪ Extension cables and device supply cables must be physically protected. Cables should not be left lying on the ground, and wheelbarrows and workers should not be allowed to pass over them. Cables should not be allowed to remain in puddles of water. ▪ Before use, electrical equipment should be visually inspected and devices with physical defects should be excluded from use. ▪ When using an electrical reinforcement bending device, protective gloves should be removed before working near the bending heads. ▪ Sharp, pointed ends should be chamfered with the appropriate type of cutter or spiral. A rubber buffer should be installed on sharp, pointed ends that cannot be corrected. ▪ It is mandatory for the personnel on duty to wear work shoes, protective glasses, hard hat, dust mask and headphones.
Laying reinforcement element reinforcement	Temporary Work Scaffolding.	<ul style="list-style-type: none"> ▪ Falling from height ▪ Traumas due to the impact of objects falling from heights. 	<ul style="list-style-type: none"> ▪ It is essential that the scaffoldings to be installed meet the TS EN 12811-1 standard conditions, regardless of their size. It is mandatory for all personnel to work on these scaffolds to have received training on working at height and to use full body safety belts and fall arrest equipment. ▪ It is mandatory for the personnel on duty to wear work shoes, protective glasses, hard hat, dust mask and headphones.

WORK TO DO	SOURCE OF DANGER	RISKS	PRECAUTION
Concrete Plant	Temporary work scaffolding. Use of electrical equipment. Chemical substance use.	<ul style="list-style-type: none"> ▪ Falling from height ▪ Traumas due to the impact of objects falling from a height. ▪ Disorders due to chemical contact. ▪ Electric shock 	<ul style="list-style-type: none"> ▪ Personnel who will work in mold works must have a Wood Moulder Level 3 (11UY0011-3) certificate. ▪ Personnel who will undertake concrete casting works must have the Concreter Level 3 (12UY0049-3) certificate. ▪ It is essential that the scaffoldings to be installed meet the TS EN 12811-1 standard conditions, regardless of their size. It is mandatory for all personnel to work on these scaffolds to have received training on working at height and to use full body safety belts and fall arrest equipment. ▪ Vibrator etc. It is essential that all electrical equipment be subjected to PAT testing and verified to be electrically safe. ▪ Extension cables and device supply cables must be physically protected. Cables should not be left lying on the ground in a casual manner, and wheelbarrows and workers should not be allowed to pass over them. Cables should not be allowed to remain in puddles of water. ▪ Repair mortars etc. MSDS of the materials should be checked by workplace physicians and employees should be informed (breathing, eye contact, etc.). ▪ It is mandatory for the personnel on duty to wear work shoes, protective glasses, hard hat, dust mask and headphones.
Wall Construction	Heavy Load Carrying. Chemicals. Temporary Work Scaffolding.	<ul style="list-style-type: none"> ▪ Orthopedic disorders. ▪ Disorders due to chemical contact. ▪ Falling from height. ▪ Traumas due to the impact of objects falling from a height. 	<ul style="list-style-type: none"> ▪ Personnel who will build walls must have a Bricklayer Level 3 (12UY0048-3) certificate. ▪ It is essential that the scaffoldings to be installed meet the TS EN 12811-1 standard conditions, regardless of their size. It is mandatory for all personnel who will work on the scaffoldings in question to be trained to work at height and to use full-body safety belts and fall arrest equipment. ▪ Mortar etc. MSDS of the materials should be checked by workplace physicians and employees should be informed (breathing, eye contact, etc.). ▪ It is mandatory for the personnel on duty to wear work shoes, protective glasses, hard hat, dust mask and headphones.

WORK TO DO	SOURCE OF DANGER	RISKS	PRECAUTION
Electrical Installation.	Temporary Work Scaffolding Electric	<ul style="list-style-type: none"> ▪ Falling from height ▪ Traumas due to the impact of objects falling from a height. ▪ Electric shock 	<ul style="list-style-type: none"> ▪ At minimum, personnel who will work in electrical installations; Must have an Electrical Plumber Level 3 (15UY0241-3) certificate. ▪ Personnel who will assemble electrical panels and panels must have, at a minimum, the Electrical Panel Installer Level 3 (12UY0075-3) certificate. Electrical or Electrical and Electronics Eng. is responsible for all electrical work. will be carried out under the supervision of ▪ Torque controlled screwdrivers and tightening equipment should be used during electrical panel/table assembly. Appropriate tightening forces must be determined in advance according to the type of switchgear or screw and nut dimensions and reported to the responsible personnel. ▪ All personnel must use appropriate types of insulated electrical gloves and work shoes according to low voltage safety limits. The suitability of the PPE in question must be specifically determined by the OHS Specialist through standards and CE markings. ▪ It is essential that the scaffoldings to be installed meet the TS EN 12811-1 standard conditions, regardless of their size. It is mandatory for all personnel working on these scaffoldings to have received training on working at height and to use full-body safety belts and fall arrest equipment.

WORK TO DO	SOURCE OF DANGER	RISKS	PRECAUTION
Lighting Element Installation	Temporary Work Scaffolding. Electric.	<ul style="list-style-type: none"> ▪ Falling from height. ▪ Traumas due to the impact of objects. falling from a height. ▪ Electric shock. 	<ul style="list-style-type: none"> ▪ The minimum number of personnel to be employed is; Must have an Electrical Plumber Level 3 (15UY0241-3) certificate. ▪ Before the installation of the lighting element, the electrical energy of the line in question must be cut off via the switchgear equipment and secured with the EKED system. ▪ Switches, commutators, etc. where electrical energy is cut off before disassembly. It should be checked with control devices such as phase voltage detectors over equipment connections. ▪ It is essential that the scaffoldings to be installed meet the TS EN 12811-1 standard conditions, regardless of their size. It is mandatory for all personnel who will work on the scaffoldings in question to be trained to work at height and to use full-body safety belts and fall arrest equipment. ▪ All personnel must use appropriate types of insulated electrical gloves and work shoes according to low voltage safety limits. The suitability of the PPE in question must be specifically verified by the OHS Specialist through standards and CE markings.

WORK TO DO	SOURCE OF DANGER	RISKS	PRECAUTION
Gypsum plaster application	Temporary Work Scaffolding. Chemical Matter. Electric	<ul style="list-style-type: none"> ▪ Falling from height. ▪ Traumas due to the impact of objects falling from a height. ▪ Electric shock. ▪ Disorders due to chemical contact. 	<ul style="list-style-type: none"> ▪ Personnel who will perform plaster/plaster operations must have a Gypsum Plaster Applicator Level 3 (12UY0055-3) certificate. ▪ It is essential that the scaffoldings to be installed meet the TS EN 12811-1 standard conditions, regardless of their size. It is mandatory for all personnel who will work on the scaffolds in question to be trained to work at height and to use full-body safety belts and fall arrest equipment. ▪ Control lighting, mixer etc. It is essential that all electrical equipment be subjected to PAT testing and verified to be electrically safe. ▪ Extension cables and device supply cables must be physically protected. Cables should not be left lying on the ground, and wheelbarrows and workers should not be allowed to pass over them. Cables should not be allowed to remain in puddles of water. ▪ Repair mortars, plaster, plaster etc. MSDS of the materials should be checked by workplace physicians and employees should be informed (breathing, eye contact, etc.). ▪ It is mandatory for the personnel on duty to wear work shoes, protective glasses, hard hat, dust mask and headphones.

WORK TO DO	SOURCE OF DANGER	RISKS	PRECAUTION
Paint	Temporary Work Scaffolding. Chemical Matter Electric	<ul style="list-style-type: none"> ▪ Falling from height ▪ Traumas due to the impact of objects falling from a height. ▪ Electric shock. ▪ Disorders due to chemical contact 	<ul style="list-style-type: none"> ▪ Personnel who will work in painting works must have a Construction Painter Level 3 (11UY0023-3) certificate. ▪ It is essential that the scaffoldings to be installed meet the TS EN 12811-1 standard conditions, regardless of their size. It is mandatory for all personnel who will work on the scaffolds in question to be trained to work at height and to use full-body safety belts and fall arrest equipment. ▪ Control lighting, mixer etc. It is essential that all electrical equipment be subjected to PAT testing and verified to be electrically safe. ▪ Extension cables and device supply cables must be physically protected. Cables should not be left lying on the ground, and wheelbarrows and workers should not be allowed to pass over them. Cables should not be allowed to remain in puddles of water. ▪ Repair mortars, paint, solvents, etc. MSDS of the materials should be checked by workplace physicians and employees should be informed (breathing, eye contact, etc.). ▪ It is mandatory for the personnel on duty to wear work shoes, protective glasses, hard hat, dust mask and headphones.
Ceramic tile etc. flooring works.	Chemical matter Electric	<ul style="list-style-type: none"> ▪ Electric shock. ▪ Disorders due to chemical contact 	<ul style="list-style-type: none"> ▪ Personnel who will work in ceramic tile works must have the Ceramic Tile Coater Level 3 (12UY0051-3) certificate. ▪ Mixer, crusher/driller etc. It is essential that all electrical equipment be subjected to PAT testing and verified to be electrically safe. ▪ Extension cables and device supply cables must be physically protected. Cables should not be left lying on the ground, and wheelbarrows and workers should not be allowed to pass over them. Cables should not be allowed to remain in puddles of water. ▪ Adhesive mortars etc. MSDS of the materials should be checked by workplace physicians and employees should be informed (breathing, eye contact, etc.). ▪ It is mandatory for the personnel on duty to wear work shoes, protective glasses, hard hat, dust mask and headphones.

WORK TO DO	SOURCE OF DANGER	RISKS	PRECAUTION
Mechanical Installation	Electric	<ul style="list-style-type: none">▪ Electric shock.	<ul style="list-style-type: none">▪ At a minimum, the personnel who will take part in the mechanical installation process; Heating and Natural Gas Internal Installation Construction Personnel must have a Level 3 (11UY0031-3) certificate.▪ It is essential that all electrical equipment be subjected to PAT testing and verified to be electrically safe.▪ Extension cables and device supply cables must be physically protected. Cables should not be left lying on the ground, and wheelbarrows and workers should not be allowed to pass over them. Cables should not be allowed to remain in puddles of water.▪ It is mandatory for the personnel on duty to wear work shoes, protective glasses, hard hat, dust mask and headphones.

8.1.2 Energy Efficiency

Energy efficiency-focused renovation topics are listed below.

- Electricity generation with monocrystalline PV system on hipped roof.
- The roofs and layout plans where PV will be installed are presented to your attention below.

Figure 9 Kocaeli- Ministry Of Youth And Sports Kandira Special Provincial Administration Kyk Dormitory Building Roof Top PV Layout Plan

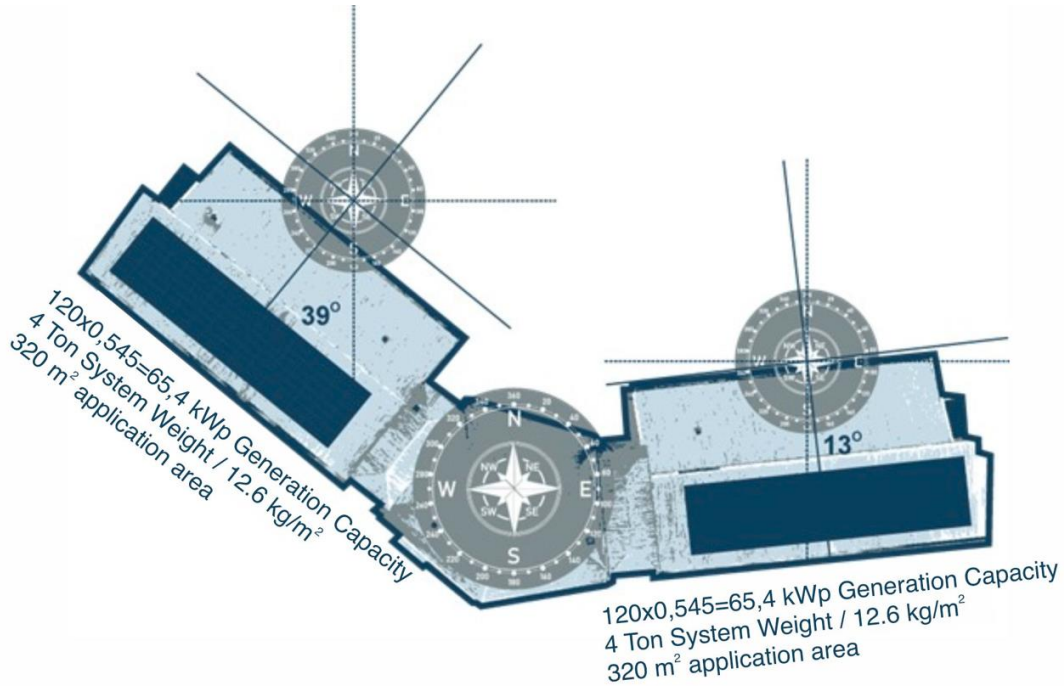

- All work must be carried out under the supervision of a qualified Electrical or Electrical Electronics Engineer.
 - All personnel involved in the work must have received training in working at heights.
 - All personnel involved in the work must use full-body safety harnesses and fall prevention equipment.
 - Horizontal safety lines must be installed on roofs for the connection of fall prevention equipment.
-
- It has been determined that the existing condition of maintaining the shaft voids and chimneys due to the change in the quantity of the current situation, as the chimney on the roof of all blocks is the boiler chimney that needs to be preserved.

Figure 10 Representative Picture Of Movement Restrictor



- It is mandatory for the truck and mobile crane to act in accordance with the traffic action plan when moving and lifting all panels and bringing them to the roof.
- Securing the transport line in lifting and transportation operations of the mobile crane (preventing entry into areas with a risk of falling).
- Inspection reports of the mobile crane, hoist, and sling should be checked, and their compliance should be verified.
- The operator controlling the mobile crane must have an operator certificate, which should be checked and verified.
- Personnel installing guiding ropes and supporting slings must have a Signaler Level 2 (15UY0218-2) Slinger Training certificate.
- All electrical hand tools (mobile concrete mixer, vibrator, concrete pump, etc.) must undergo PAT tests. PAT test reports will be requested and checked before work. During field inspections, the presence of PAT control and approval labels on electrical devices will be verified. Devices without compliance labels are not allowed for use. (Extension cables are also included in this scope.)
- Personnel working on electrical installations must have a minimum of Level 3 Electrical Installer (15UY0241-3) certification.
- Personnel involved in the assembly of electrical panels and boards must have a minimum of Level 3 Electrical Panel Assembler (12UY0075-3) certification.
- Torque-controlled screwdrivers and tightening equipment must be used during the assembly of electrical panels/boards. Appropriate tightening forces should be predetermined based on the type of switchgear or the dimensions of screws and nuts and communicated to the responsible personnel.
- The grounding line of the electrical system must be reported by authorized Electrical or Electrical Electronics Engineers.
- Insulated work gloves (suitable for low voltage conditions) and insulated work shoes must be used to protect against electric shocks.

Figure 11 Representative Picture Of Movement Restrictor



- Construction safety net or construction safety mesh is a net system used to prevent human or material falls in construction areas. This precaution against falls on construction sites should comply with TSE 1263-1 and TSE 1263-2 standards in terms of raw material, production method, and application. Safety nets are the most effective overall safety measure among passive fall arrest systems.
- Installation can be done horizontally, vertically, or at an angle depending on the area.
- The personnel performing the installation should have technical knowledge about angular values, anchor point selection, and the placement of the net.
- To prevent materials or objects from the chimneys to be shortened in A1 Block and A2 Block from falling into the excluded area adjacent to the blocks, a safety net installation process should be implemented.

Table 11 Roof Top PV Works Control Table

Work to do:	Establishment of Photovoltaic Energy Facility	
WORKING METHOD		
<u>Technical Description and Requirements</u>		
Construction Technique and Technology		
<ul style="list-style-type: none"> – Panel fixing lightweight construction will be secured to the roof with drilling and fastening sets using screw nuts. The panels transported to the roof by a mobile crane will be fixed to the mentioned construction in accordance with the project, and connection cables will be drawn. Energy and grounding cables, connected by connectors, will be linked to the inverter and solar power plant panel installed on the main panel. 		
Use of Work Equipment		
<ul style="list-style-type: none"> – Truck – mobile crane – Load carrying equipment (eyebolt, sling, hook, chain) – torque wrench – cordless drill – Screwdriver set – multimeter – Cable cutting stripping hand equipment (chisel, pliers, pliers nose etc.) – Silicone gun 		
Use of Chemical Substances		
<ul style="list-style-type: none"> – Silicone 		
Access to Workspace		
<ul style="list-style-type: none"> – The access road is given in plan form under the title of General Construction Technique. <ul style="list-style-type: none"> • The maximum speed for trucks within the campus is limited to 20 km. • The maximum speed for mobile cranes within the campus is limited to 20 km. 		
PPE - GENERAL	Need for Trained Personnel	
<ol style="list-style-type: none"> 1. EN 397 HELMET 2. EN 420 INSULATED GLOVES 3. EN 345 INSULATED WORK SHOES 200J 4. EN 340 GENERAL WORK CLOTHES 5. FULL BODY SEAT BELT (EN 361) 6. ROPE BRAKING SYSTEM (EN 353) 7. SAFETY HOOK (EN 362) 8. FALL PREVENTOR (EN 355) 	<ol style="list-style-type: none"> 1. Electrical and Electronics Engineer 2. Truck driver with a CLASS C driver's license 3. Mobile Crane Operator (Auth. Cap.: 13UY0172-3 Level 3) 4. Pointer (Auth. Cat.: 15UY0218-2 Level 2) 5. Electrical Panel Installer (Auth. C.:12UY0075-3 Level 3) 	

Table 12 RISK ANALYSIS

WORK TO DO	DANGER	RISK	PRECAUTION
Transportation of materials	Galleon	Injury, death as a result of traffic accident	<ul style="list-style-type: none"> ▪ The truck will be operated by employees holding a Class C driving license. ▪ The urban speed limit will not be exceeded (50 km/h). ▪ The speed limit within the building campus area is restricted to 20 km/h. Movements and maneuvers within the area will be observed by the Occupational Safety and Health (OSH) specialist.
Transportation of materials	PV panels and mounting parts		<ul style="list-style-type: none"> ▪ All materials will be placed evenly in the truck bed, considering the center of gravity. ▪ The units will be secured with straps. ▪ Assembly parts will be transported packaged on a pallet. ▪ The truck side and rear doors will be closed and secured.
Transport and unloading of materials	Mobile Crane and lifting equipment	Injury or death due to PV panels or parts falling over	<ul style="list-style-type: none"> ▪ The Mobile Crane Operator (Cert. No: 13UY0172-3 Level 3) is authorized to use the crane. ▪ Rigging and guidance will be performed by signalers with authorized signaling certificates. ▪ The crane's periodic inspection report will be checked and verified by the HSE specialist before work (it will be requested to be obtained within a maximum of 6 months). ▪ Periodic inspection reports for straps, chains, hooks, etc., will be checked and verified by the HSE specialist before work (it will be requested to be obtained within a maximum of 6 months). ▪ Straps, chains, hooks will be visually inspected before work. Their lifting capacity and physical condition will be confirmed. ▪ The mobile crane's hydraulic stabilizing legs will be secured to the ground. ▪ Before lifting operations, the main boom angle of the mobile crane and lifting capacities related to that angle will be checked. ▪ The signaler will guide the load through a control rope. ▪ Access to the work area will be restricted during lifting and transportation operations. Passing under the load is prohibited. ▪ Warning signs will be installed. ▪ The work will be subject to the WORK PERMIT SYSTEM.

WORK TO DO	DANGER	RISK	PRECAUTION
Assembly work	working at height		<ul style="list-style-type: none"> ▪ T-type safety netting or edge protection railing will be installed to prevent the fall of large parts and workers. ▪ According to TS EN 1263-2 standard, the width of the T-type safety net should be at least 2 m, and the vertical installation height should be a maximum of 1 m. ▪ Workers must have received Working at Heights with Rope Access Training before starting work. These training sessions will be provided at a minimum by experts holding the IRATA (Industrial Rope Access Trade Association) International Level 2 Certificate. ▪ During work on the roof, especially when working near the edge where the risk of falling is high (within 1 m from the edge), restraint systems (horizontal lifelines) will be used. ▪ Materials to be assembled will not be held at the edges, and during non-working hours, they will be secured to the ground with a free material restraint net. ▪ The perimeter of the building where assembly will take place will be marked with safety tapes, preventing the entry of workers and third parties.
Cutting off line energy via electrical panel	Power board, line cable	Injury or death as a result of the load falling during lifting, carrying and lowering	<ul style="list-style-type: none"> ▪ Panel intervention will be carried out under the supervision of an Electrical or Electrical Electronics Engineer, with a minimum Electrical Panel Assembler (Cert. No: 12UY0075-3 Level 3). ▪ After the power is cut off, it will be verified with a multimeter that there is no energy in the neutral and ground lines. ▪ The panel in question will be locked and tagged. ▪ The LOTO (Lockout/Tagout) key for the lock system will be held by the technician who locks it. It is forbidden to give this key to anyone else before the work is completed. ▪ Before disconnecting device connections and making new connections, it will be verified again with a multimeter that there is no energy.

WORK TO DO	DANGER	RISK	PRECAUTION
Cutting off the line energy and re-energizing it via the electrical panel	Power board, line cable	Fall from height, material fall	<ul style="list-style-type: none"> ▪ Panel intervention will be carried out under the supervision of an Electrical or Electrical Electronics Engineer, with a minimum Electrical Panel Assembler (Cert. No: 12UY0075-3 Level 3). ▪ During electrical works, 1kV insulated gloves in accordance with EN 60903:2003 standard, insulated electrician shoes in accordance with EN 344 standard, and an insulated mat (EN 60243-1) or table (EN 60243-1) will be placed on the ground. ▪ The work will be carried out by a minimum of two technical workers. These individuals will not come into contact with each other during the work. ▪ Technical personnel who will perform the work will be provided with training on the effects of electric shock and initial intervention, and a practical exercise will be conducted.
PV Panel and construction Installation	Assembly works	Injury or death due to electric shock due to unauthorized switching on of the energy by other people or technical problems	<ul style="list-style-type: none"> ▪ PV panels and construction assembly will be carried out by a Machine Assembler (Cert. No: 12UY0105-3 Level 3). ▪ Throughout the assembly, a helmet and general protection gloves will be used to prevent head and hand injuries.

- KASKAD sectional condensing premix floor type boiler plant.

The existing boilers will be dismantled, removed from the building, and transported. The process of transporting the new boilers, moving them into the building, and assembling them will be outlined in a work method prepared by the contractor and submitted for approval by the consultant. After approval of the method, work can commence. The main elements and considerations for the boiler installation process are listed below.

- All work must be carried out under the supervision of a qualified Mechanical Engineer.
- A method for the dismantling and removal of the existing boiler and its delivery to the university must be defined.
- The truck used in the transport process of the new boiler must adhere to the traffic action plan.
- The route to be used in the removal of the dismantled boiler and the installation of the new boiler must be specified in the construction method. (If wall demolition and reconstruction are required, personnel involved should have a Bricklayer Level 3 (12UY0048-3) certificate.)
- Personnel involved in the mechanical installation process must have a minimum of Heating and Natural Gas Internal Installation Construction Personnel Level 3 (11UY0031-3) certificate.
- The suitability of the equipment to be used in lifting and transporting the boiler in the indoor environment must be verified through periodic inspection reports (issued by authorized Mechanical Engineers).
- The surroundings of the heat center during the renovation process must be enclosed with caution tape to prevent unauthorized personnel entry.
- Personnel performing electrical installation and panel assembly tasks must have a minimum of an Electrical Panel Assembler Level 3 (12UY0075-3) certificate.
- The grounding line of the electrical system must be reported by authorized Electrical or Electrical Electronics Engineers.
- For protection against electrical shocks, insulated gloves (suitable for low-voltage conditions) and insulated work shoes must be used.
- All personnel handling heavy loads must receive training in manual lifting and carrying.

Table 13 KASKAD Sectional Condensing Premix Floor Type Boiler Plant Control Table

Work to do:	Natural gas boiler plant.
WORKING METHOD	
Technical Description and Requirements	
Construction Technique and Technology	
<ul style="list-style-type: none"> – The existing boiler will be dismantled, and in its place, a smaller-sized boiler will be securely fixed to the floor. Subsequently, the burner, natural gas pipeline connections, as well as the supply and return hot water connections, will be established. 	
Use of Work Equipment	
<ul style="list-style-type: none"> – Truck – Mobile crane – Load carrying equipment (eyebolt, sling, hook, chain) – Torque wrench – Cordless drill – Screwdriver set – Multimeter – Cable cutting and stripping hand equipment (chisel, pliers, needle nose, etc.) – Mechanical assembly equipment (pipe cutting, bending) 	
Use of Chemical Substances	
<ul style="list-style-type: none"> – Cleaning chemicals – Mechanical system oils 	
Access to Workspace	
<ul style="list-style-type: none"> – The access road is given in plan form under the title of General Construction Technique. <ul style="list-style-type: none"> • The maximum speed for trucks within the campus is limited to 20 km. • The maximum speed for mobile cranes within the campus is limited to 20 km. 	
PPE - GENERAL	Need for Trained Personnel
<ol style="list-style-type: none"> 1. EN 397 HELMET 2. EN 420 GENERAL PURPOSE GLOVES 3. EN 345 SAFETY SHOES 200J 4. EN 420 INSULATED GLOVES 5. EN 345 INSULATED WORK SHOES 200J 6. EN 340 GENERAL WORK CLOTHES 	<ol style="list-style-type: none"> 1. MECHANICAL ENGINEER 2. TRUCK DRIVER WITH CLASS C DRIVER'S LICENSE 3. MOBILE CRANE OPERATOR (AUT. C.: 13UY0172-3 LEVEL 3) 4. MARKER (AUT. C.: 15UY0218-2 LEVEL 2) 5. HEATING AND NATURAL GAS DOMESTIC CONTACT. THU. LEVEL 3 (11UY0031-3) 6. ELECTRICAL PANEL INSTALLER (AUTHORITY: 12UY0075-3 LEVEL 3)

Table 14 RISK ANALYSIS

WORK TO DO	DANGER	RISK	PRECAUTION
Material Handling	Truck	Injury, death as a result of traffic accident	<ul style="list-style-type: none"> ▪ The truck will be used by employees with a class C driver's license. ▪ City speed limit will not be exceeded. (50km/h) ▪ The speed limit of the building campus area is limited to 20 km/h. Movements and maneuvers on the field will be observed by an OHS specialist.
Material Handling	PV panels and mounting parts		<ul style="list-style-type: none"> ▪ All materials will be placed balancedly in the center of the truck bed, taking into account the center of gravity. ▪ The unit will be fixed with straps. ▪ Assembly parts will be transported packaged on pallets. ▪ Truck side and rear covers will be closed and fixed
Material Handling and Unloading	Mobile Crane and lifting equipment	Injury or death due to PV panels or parts falling over	<ul style="list-style-type: none"> ▪ The crane can be used by a Mobile Crane Operator (Auth. ID: 13UY0172-3 Level 3). ▪ Slings and guidance will be carried out by signalmen with authorization certificates. ▪ The crane periodic inspection report will be checked and verified by an OHS expert before work. (It will be requested to be provided within a maximum period of 6 months.) ▪ Periodic inspection report of slings, chains, eye bolts and hooks will be checked and verified by the OHS expert before the work. (It will be requested to be provided within a maximum period of 6 months.) ▪ Slings, eye bolts and hooks will be visually checked before work. Carrying capacity and physical condition will be verified. ▪ Mobile crane hydraulic fixing legs will be fixed to the ground. ▪ Before the lifting operation, the mobile crane boom angle and the lifting capacities related to that angle will be checked. ▪ The load will be directed by the pointer over the control rope. ▪ Access to the work area will be restricted throughout the lifting and transport operation. Passing under load is prohibited. ▪ Warning signs will be installed. ▪ Work will be subject to the WORK PERMIT SYSTEM.

WORK TO DO	DANGER	RISK	PRECAUTION
Cutting off the Natural Gas Line	Natural gas		<ul style="list-style-type: none"> ▪ Before dismantling, the natural gas line must be cut and secured with LOTO. ▪ It should be checked with gas detection devices that there is no shortage of natural gas. ▪ After the new line connections are completed, gas must be re-introduced in accordance with LOTO rules. After opening the gas valves, it should be checked for leaks with gas detection devices.
Cutting off the electrical power through the electrical panel, re-energizing	Power board, line cable	Injury or death as a result of the load falling during lifting, carrying and lowering	<ul style="list-style-type: none"> ▪ Panel intervention will be carried out by the Electrical Panel Installer (Auth. C.: 12UY0075-3 Level 3). ▪ During electrical work, 1kV insulated gloves in accordance with EN 60903:2003 standard, insulated electrician work shoes in accordance with EN 344 standard will be used, and an insulated mat (EN 60243-1) or stand (EN 60243-1) will be placed on the floor. ▪ Work will be carried out by at least two technical employees. These people will not come into contact with each other during work. ▪ Technical personnel who will carry out the work in question will be trained on the effects of electric shock and first response and a drill will be carried out.

- Along with the spare parts of the existing motor & pump elements in the circulation system; replacement with integrated frequency controlled high efficiency systems.
 - Personnel responsible for motor line and panel switchgear connections must have a minimum certification of Electrical Panel Assembler Level 3 (12UY0075-3).
 - Torque-controlled screwdrivers and tightening equipment should be used during electrical panel/board assembly. Appropriate tightening forces should be predetermined based on the type of switchgear or nut and bolt sizes and communicated to the responsible personnel.
 - Insulated gloves (suitable for low voltage conditions) and insulated work boots should be worn to protect against electrical shocks.
 - EKED system should be used for panel safety.
 - All personnel involved in carrying heavy loads must undergo manual lifting and carrying training.

Table 15 Installation Of Motor Pump Combinations With Integrated Frequency Control Work Control Table

Work to do:	Installation of motor pump combinations with integrated frequency control.	
WORKING METHOD		
Technical Description and Requirements		
Construction Technique and Technology		
<ul style="list-style-type: none"> - The current engine energy will be cut off, first the electrical connections will be removed using a screwdriver with a suitable head, and then the fixing connections will be removed and stacked on the floor. Pumps will be removed with appropriate hand equipment and stacked on the floor. Combined motor pump elements will be fixed to the line pipe in accordance with the project and electrical connections specified by the manufacturer will be made. - During panel assembly, a ferrule of appropriate size will be used and the live end will not be left exposed. 		
Use of Work Equipment		
<ul style="list-style-type: none"> - Electrical tools (Pliers, control pen, screwdriver, etc.) - Multimeter 		
Use of Chemical Substances		
<ul style="list-style-type: none"> - It is not intended to use any chemicals. 		
Access to Workspace		
<ul style="list-style-type: none"> - The heat center is inside the building. 		
Transportation of Materials		
<ul style="list-style-type: none"> - Materials will be carried manually. (Manual handling training should be given.) 		
PPE - GENERAL	Need for Trained Personnel	
<ol style="list-style-type: none"> 1. EN 397 HELMET 2. EN 420 INSULATED GLOVES 3. EN 345 INSULATED WORK SHOES 4. EN 340 GENERAL WORK CLOTHES 5. 	<ol style="list-style-type: none"> 1. Electrical Panel Installer (Auth. C.:12UY0075-3 Level 3) 	

Table 16 RISK ANALYSIS

WORK TO DO	DANGER	RISKS	PRECAUTION
Cutting off line energy via electrical panel	Power board, line cable	Injury or death due to electric shock due to unauthorized switching on of the energy by other people or technical problems	<ul style="list-style-type: none"> ▪ Panel intervention will be carried out by a minimum Electrical Panel Assembler Level 3 (12UY0075-3) under the supervision of an Electrical or Electrical Electronics Engineer. ▪ After the power is cut off, it will be verified with a multimeter that there is no energy in the neutral and ground lines. ▪ The panel will be labeled and locked in accordance with LOTO rules. ▪ Before disconnecting device connections and making new connections, it will be verified again with a multimeter that there is no energy.
Assembly, re-energization	Power board, line cable	Electric shock during motor and panel connection.	<ul style="list-style-type: none"> ▪ Motor connections will be carried out by a minimum Electrical Panel Assembler Level 3 (12UY0075-3) under the supervision of an Electrical or Electrical Electronics Engineer. ▪ Panel intervention will be carried out by a minimum Electrical Panel Assembler Level 3 (12UY0075-3) under the supervision of an Electrical or Electrical Electronics Engineer. ▪ During electrical work, 1kV insulated gloves compliant with EN 60903:2003 standard and insulated electrician work shoes compliant with EN 344 standard will be used. An insulated mat (EN 60243-1) or table will be placed on the ground. ▪ The work will be carried out by a minimum of two technical workers. These individuals will not come into contact with each other during the work. ▪ Technical personnel performing the work will be provided with training on the effects of electric shock and initial intervention, and practical exercises will be conducted.

- Replacement of luminaires that have not been converted to LED with high-efficiency LED luminaires of the same size.
 - Personnel working on fixture replacement must have a minimum of Electrical Installer Level 3 (15UY0241-3) certification.
 - Insulated gloves (suitable for low voltage conditions) and insulated work shoes must be used to prevent electric shocks.
 - Personnel making connections inside the panel must have Electrical Panel Assembler (certification: 12UY0075-3 | Level 3).
 - EKED system must be used for panel safety.
 - If the protection fuse of the lighting line is not labeled, labeling will be done.
 - Mobile work scaffolds must comply with TS EN 12811-1 standards. All personnel working on these scaffolds must have received working at heights training and must use full-body safety harnesses and fall prevention equipment.
 - Personnel responsible for scaffold installation must have Scaffold Installation Operator Level 3 (12UY0056-3) certification.

Figure 12 Mobile Scaffolding Sample Demonstration



Table 17 Completing The LED Conversion Of Existing Lighting Elements Works Control Plan

Work to do:	Completing the LED Conversion of Existing Lighting Elements
WORKING METHOD	
Technical Description and Requirements	
Construction Technique and Technology	
<ul style="list-style-type: none"> ▪ The power supply to the lighting fixture will be cut off from the column and line connection, and this will be verified using a multimeter. ▪ Existing lighting fixtures will have their securing screws removed. The fixture will be detached, and terminal connections will be exposed by removing any cover. ▪ Cable power connections at the terminals will be removed using appropriate screwdrivers. Visual inspections will be conducted on the cable, and adjustments will be made to prepare it for the connection of the new fixture. ▪ The new fixture will be connected via the terminals. The connection integrity will be manually checked, and the fixture will be secured to the ceiling using the connection elements provided by the manufacturer. 	
Use of Work Equipment	
<ul style="list-style-type: none"> – - Electrical tools (Pliers, control pen, screwdriver, etc.), H or L type mobile scaffolding 	
Use of Chemical Substances	
<ul style="list-style-type: none"> – - It is not intended to use any chemicals. <ul style="list-style-type: none"> • Newly supplied LED luminaire will be installed. 	
Access to Workspace	
<ul style="list-style-type: none"> – The work area is at various points within the building. Internal transportation routes will be used. 	
Transportation of Materials	
<ul style="list-style-type: none"> – Materials will be carried manually. 	
PPE – GENERAL	Need for Trained Personnel
<ol style="list-style-type: none"> 1. EN 397 HELMET 2. EN 420 INSULATED ELECTRICAL GLOVES 3. EN 345 INSULATED WORK SHOES 4. EN 340 GENERAL WORK CLOTHES 5. FULL BODY SEAT BELT (EN 361) 6. ROPE BRAKING SYSTEM (EN 353) 7. SAFETY HOOK (EN 362) 8. FALL PREVENTOR (EN 355) 	<ol style="list-style-type: none"> 1. ELECTRICAL INSTALLER LEVEL 3 (15UY0241-3) 2. ELECTRICAL PANEL INSTALLER (ADJ. C.:12UY0075-3 LEVEL

Table 18 RISK ANALYSIS

WORK TO DO	DANGER	RISKS	PRECAUTION
Cutting off line energy via electrical panel	Power board, line cable	Injury or death due to electric shock due to unauthorized switching on of the energy by other people or technical problems	<ul style="list-style-type: none"> ▪ Panel intervention electrical or Electrical and Electronics Engineering. It will be carried out under the supervision of at least an Electrical Panel Installer (Author. K.: 12UY0075-3 Level 3). ▪ After the power is cut off, it will be verified that there is no energy in the neutral and ground lines by using a multimeter. ▪ The panel in question will be locked and labeled in accordance with EKED rules. ▪ Before disconnecting the device onnections and making new connections, it will be verified that there is no power again by using a multimeter.

WORK TO DO	DANGER	RISKS	PRECAUTION
Disassembly and assembly	dock	Falling from high,	<ul style="list-style-type: none"> ▪ H or L type mobile scaffolding will be installed. The scaffolding in question must comply with TS EN 1004-1 standards. Scaffolding installation will be carried out by personnel with a Scaffolding Installation Personnel certificate. (Qualification Code: 12UY0056-3 Level 3) ▪ The installed mobile scaffolding must be fixed with the fixing elements provided by the manufacturer before work. Working in a mobile position is strictly prohibited. ▪ The completed scaffoldings will be checked and approved by the Field OHS Specialist. The use of unapproved mobile scaffolding is prohibited. ▪ Maximum carrying capacity information and warning signs will be on the pier. ▪ There will be kickplates on the scaffolding against material falls.
Disassembly, Assembly, re-energization	Power board, line cable	material fall	<ul style="list-style-type: none"> ▪ Luminaire disassembly and assembly; It will be carried out by technical personnel with ELECTRICAL INSTALLER LEVEL 3 (15UY0241-3) qualification certificate. ▪ Before disassembly, it will be verified that there is no electric current using a multimeter. In the meantime, not only phase lines but also grounding and neutral lines will be checked. ▪ Panel intervention electrical or Electrical and Electronics Engineering. It will be carried out at least by an Electrical Panel Installer (Author. K.: 12UY0075-3 Level 3) under the supervision of an Electrical Panel Installer. ▪ During electrical work, 1kV insulated gloves in accordance with EN 60903:2003 standard, insulated electrician work shoes in accordance with EN 344 standard will be used, and an insulated mat (EN 60243-1) or stand (EN 60243-1) will be placed on the floor. ▪ Work will be carried out by at least two technical employees. These people will not come into contact with each other during work. ▪ Technical personnel who will carry out the work in question will be trained on the effects of electric shock and first response and a drill will be carried out.

- Thermal insulation installation for uninsulated installation elements and heat exchanger.
 - At a minimum, the personnel who will take part in the mechanical installation process; Must have Heating and Natural Gas Internal Installation Construction Personnel Level 3 (11UY0031-3) certificate.

Table 19 Plumbing Insulation Works Control Plan

Work to do:	Plumbing Insulation	
WORKING METHOD		
Technical Description and Requirements		
Construction Technique and Technology		
Insulation jackets installed in appropriate sizes will be placed on the installation element to which they will be applied and the jacket will be fixed using fastening ropes / velcro.		
Use of Work Equipment		
– No equipment use is anticipated.		
Use of Chemical Substances		
– It is not intended to use any chemicals.		
Access to Workspace		
– The work area is in the basement of the building and existing access roads will be used.		
Transportation of Materials		
– It will be carried by hand.		
PPE - GENERAL	Need for Trained Personnel	
1. EN 397 HELMET	1. Heating and Natural Gas Internal Installation Per. Level 3 (11UY0031-3)	
2. EN 420 GENERAL PURPOSE GLOVES		
3. EN 345 SAFETY SHOES 200J		
4. EN 340 GENERAL WORK CLOTHES		

- A risk list was not deemed necessary for this issue. General risk analysis rules apply

- Establishing the energy monitoring system and automation system in accordance with EN ISO 50001 Energy Management System conditions and ensuring its effectiveness.
 - Personnel who will work in the installation of energy monitoring systems and automation systems must have, at a minimum, the Automation Systems Installer Level 4 (12UY0076-4) certificate.
 - Insulated work gloves (suitable for low voltage conditions) and insulated work shoes should be used against electric shock.
 - LOTO system should be used for panel security.

Table 20 Electronic Building Management System & Automation System Works Control Plan

Work to do:	Electronic Building Management System & Automation System General Construction Technique	
WORKING METHOD		
Technical Description and Requirements		
Construction Technique and Technology		
<ul style="list-style-type: none"> - Control cables and flowmeter cables of central air conditioning systems such as boilers and heat pumps will be pulled to the floor MCC & DCC panel. - Motor pump control cables will be pulled to the floor MCC & DCC panel and frequency inverter inputs will be made. - Line pressure difference and temperature sensors will be connected to the installation in accordance with the project and signal cables will be drawn to floor MCC & DCC panels. - Floor MCC & DCC cables will be pulled to the central panel and connected to switches etc. connections will be made. 		
Use of Work Equipment		
<ul style="list-style-type: none"> - Electrical tools (Pliers, control pen, screwdriver, etc.), cable cutting/stripping accessories, multimeter 		
Use of Chemical Substances		
<ul style="list-style-type: none"> - It is not intended to use any chemicals. 		
Access to Workspace		
<ul style="list-style-type: none"> - Work will be carried out throughout the building and existing transportation routes will be used. 		
Transportation of Materials		
<ul style="list-style-type: none"> - It will be carried by hand. 		
PPE - GENERAL	Need for Trained Personnel	
<ol style="list-style-type: none"> 1. EN 397 HELMET 2. EN 420 INSULATED WORK GLOVES 3. EN 345 INSULATED WORK SHOES 200J 4. EN 340 GENERAL WORK CLOTHES 	<ol style="list-style-type: none"> 1. ELECTRICAL PANEL INSTALLER (AUTHORITY: 12UY0075-3 LEVEL 3) 2. AUTOMATION SYSTEMS INSTALLER (12UY0076-4 LEVEL 4) 	

Table 21 RISK ANALYSIS

WORK TO DO	DANGER	RISK	PRECAUTION
Cutting off line energy via electrical panel	Power board, line cable	Electric shock	<ul style="list-style-type: none"> ▪ The intervention in the electrical panel will be carried out by a minimum Electrical Panel Assembler (Certification: 12UY0075-3 Level 3) under the supervision of an Electrical or Electrical Electronic Engineer. ▪ After cutting off the power supply, the absence of energy in the neutral and ground lines will be confirmed using a multimeter. ▪ The panel will be locked and tagged according to LOTO (Lockout/Tagout) rules. ▪ Before removing and establishing new connections, it will be ensured again through a multimeter that there is no energy. ▪ The tasks will be performed by a minimum of two technical workers. During the work, these individuals will not make physical contact with each other. ▪ Technical personnel performing the task will receive training on the effects of electrical shock and first aid, including practical exercises.

- The risk analysis lists are prepared for example purposes. The contractor must conduct detailed risk analyses for each work under its responsibility by taking these lists into consideration. The risk analyses should be prepared in accordance with the Occupational Health and Safety Risk Assessment Regulation (Official Gazette: 29.12.2012/28512) and revised as necessary.

9. Determination of Risks & Control Measures

9.1 Determination of Risks and Control Measures Affecting the General Construction Site

The entire construction sites have been examined through solid models created by drones, and efforts have been made to identify site risks. The risks identified as a result of this examination are listed below in bullet points. Objective evidence for these items is provided under the “[Pre-Construction Information & Site Plans](#)” heading in this report.

- The areas mentioned below must be inspected by the Contractor's OHS Specialist, and if necessary, additional safety measures must be communicated to the workers.
- Site risks may not be limited to these findings; if the Contractor encounters risky areas beyond these findings, they must immediately report this to the Main Contractor's OHS Specialist,
 - a) Areas with a level difference reaching 2m have been observed. This information should be taken into account during vehicle maneuvers.
 - b) Concrete stairs without appropriate railings have been observed. They pose a falling risk for employees.
 - c) Concrete stairs without appropriate railings have been observed. They pose a falling risk for employees.

9.2 Determining Possible Business-Related Risks and Control Measures and Evaluating the Impact on Third Parties

As part of the project, risks related to the structural feasibility process are presented in tabular form under the heading “General Construction Rules and Management of Works”. Apart from the risks in question;

- In addition to these risks, the following points should be considered regarding accidents that may occur when workers access the buildings within the project;
 - Actions must be taken in accordance with the traffic action plans specified in the report.
 - All individuals inside the vehicle, including rear seat passengers, are required to wear seat belts.
 - Vehicle drivers must strictly adhere to traffic regulations and speed limits.
 - Visual checks, such as fuel, oil leakage, tire treads, and pressure status, must be performed by the driver before vehicle operation. The use of faulty or defective vehicles is prohibited. Identified defects will be immediately reported to the Subcontractor's OHS Specialists.
 - Passengers should not refrain from warning the drivers if they encounter any behavior by the drivers that violates traffic rules. This should be immediately reported to the Subcontractor's OHS Specialists.
- The maneuvers of trucks, drilling machines, and other construction machinery, especially around the building, inherently involve risks. Before accessing the site, internet access to building floor models should be provided, and the areas where work will be conducted, road elevations and slopes, road width, and approach limits should be evaluated. Access links to building floor models can be requested from the main contractor via phone or email.

- Pedestrian movements should be taken into account when cars, vans, trucks, and construction machinery are used in the vicinity of the building. Pedestrian crossings should always be given priority. The proper functioning of the reversing warning sirens on trucks, vans, and construction machinery should be checked before using any vehicle.
- Except in necessary cases, the use of trucks and construction machinery is not permitted during nighttime hours. In urgent situations, the work permit system will be activated, and permission will be requested from the HSE specialist with a justification.
- Third parties and stakeholders should not be allowed to approach within 20 meters of drilling operations and machinery operations. For this purpose, safety barriers should be placed around the work area, and warning signs should be installed.

9.3 Risks Arising from Overlapping Tasks in Terms of Time and Space

The plans have been reviewed, and no risks have been observed due to overlapping tasks. In the event of encountering overlapping tasks in terms of time and space after the construction work has begun, the contractor will evaluate this situation in the work plan and risk analyses and report it to the consultant. After taking appropriate measures to address the risks, work will commence following the approval of the Consultant.

10. Determining Work Equipment Needs and Specifications

- The contracting firm must determine all devices and equipment it will use during the work, specifying safety directives⁵ (CE Marking Regulation), relevant standards,⁶ and providing a list along with periodic inspection reports to the Consultant.
- All electrical devices and equipment must undergo Portable Appliance Testing (PAT), and their electrical suitability must be indicated by PAT approval labels.

⁵ Relevant Directives;

- MACHINERY SAFETY REGULATION (2006/42/EC)
- REGULATION ON ELECTRICAL EQUIPMENT DESIGNED FOR CERTAIN VOLTAGE LIMITS (2014/35/EU)
- PRESSURE EQUIPMENT REGULATION (2014/68/EU)
- REGULATION ON GAS-BURNING DEVICES (2016/426/EU)

⁶ Relevant standards (must be reviewed separately for each device.)

- TS EN ISO 12100 Safety in machinery - General principles for design - Risk assessment and risk reduction
- TS EN 60204-1 Safety in machines – Electrical equipment of machines – part 1: General rules
- TS EN 60335-1 Safety rules - For electrical devices used in homes and similar places - Part 1: General rules
- TS 1203 EN 286-1 Tanks – Simple – Non-flammable – Pressurized
- TS 10116 Cranes – Test and inspection methods
- TS ISO 9927-1 Cranes-Inspections-Part 1: General

10.1 Determination of Protective Equipment Needs

10.1.1 Collective protection Systems

Table 22: LIST OF COLLECTIVE PROTECTION SYSTEMS

TYPE OF PROTECTION	PLACE OF USE	DURATION OF USE	STANDARDS
SAFETY STRIP	RISKY WORK AREAS (PIECES FALLING FROM HEIGHT, USE OF WORK MACHINE, RISK OF FALLING, WORKING WITH ELECTRICITY, CARRYING HEAVY LOAD)	Until the local work is completed.	-
ACCESS / FALL RESTRICTOR RAILWAY	DRILLING AREAS, DEMOLISHED EXTERIOR WALL EDGES.	Until the local work is completed.	TS EN 13374+A1
LIFELINE	WORKS ON SCAFFOLDINGS, WORKS ON THE ROOF, WORKS CLOSE TO DEMOLISHED FACADE WALLS.	Until the local work is completed.	TS EN 795
SAFETY NET	THE DEEP SPACE CREATED BY THE ELEVATED HEIGHT BETWEEN THE OUT OF SCOPE BUILDING AND THE DINING HALL.	Until the exterior works in the dining hall are completed.	TS EN 1263-2

10.1.2 Personal Protective Equipment

Table 23: PPE TABLE

DEFINITION	CATEGORY	MAINTENANCE/RENOVATION PERIOD	MAX USAGE TIME	STANDARDS	COLOR CODE
SAFETY HELMET	II	1 YEAR	CONTINUALLY	TS EN 397+A1	White: Engineer Yellow: Employee Red: OHS Specialist. Green:ERT ⁷
EARPLUG	I	DAILY	DURING NOISY OPERATION (≥80dB)	TS EN 352-2	-
PROTECTIVE GOGGLES	I	3 MONTHS	DURING ANY WORK DURING THE RISK OF OBJECTS INTO THE EYES AS SPECIFIED IN THE RISK ANALYSIS	TS EN ISO 16321-3	-
GENERAL PURPOSE WORK GLOVES	I	3 MONTHS	CONTINUALLY	TS EN ISO 21420	-
WORK SHOES	II	1 YEAR	CONTINUALLY	TS EN ISO 20347	-
HALF FACE MASK	I	DAILY	DUSTY WORK	TS EN 140	-
FULL-BODY SAFETY HARNESS	II	1 YEAR	ALL KINDS OF WORKING AT HEIGHT	TS EN 361	-
FALL PREVENTIVE EQUIPMENT AND LIFE LINES	II	1 YEAR	ALL KINDS OF WORKING AT HEIGHT	EN 355	-
INSULATED GLOVES AND WORK SHOES	I	3 MONTHS	ELECTRICAL WORKS	TS EN ISO 21420	-

⁷ EMERGENCY RESPONSE TEAM

11. Work Permit System

The actions subject to the work permit system are listed below:

- All types of night work.
Work cannot be conducted without approval from the OHS Specialist. Elements to be checked for night work are listed as follows;
 - Approval from building management and technical units.
 - Adequate lighting and light level control for outdoor work.
 - Whether technical teams from the building can accompany the work.
 - Work hours of the employees.
 - Information about the working environment (Photos).
 - Professional qualifications of the employees,
- Working at height,
Facade thermal insulation installation
 - Installation of the work scaffold in accordance with TS EN 12811-1 standard.
 - Fixing the work scaffold to the ground and facade at suitable points.
 - Installation of horizontal and vertical lifelines.
 - Specification of the capacities of the work scaffold and lifelines (total number of users - weight).
 - Training for personnel working at heights (Working at Heights Training), with a note in health examination reports indicating suitability for working at heights.
- Within the scope of this project, working in enclosed spaces, welding, plasma cutting, and similar works are not anticipated. However, if there is a need for such work, even in partial and simple tasks, the work permit system will be implemented.

The work permit system will be completed through a Google Form on mobile phones and will be provided with approval from the OHS specialist. The link to the form must be requested from the Subcontractor OHS Specialists.

The process is described below;

1. It is mandatory to prepare and request approval for the WORK PERMIT form for activities listed under work permits. However, once the form is registered in the system, work can only begin after approval is granted. Starting work without approval is prohibited.
 - a) Necessary personal protective equipment must be provided and used consistently.
 - Before starting work, the personal protective equipment to be used must be visually inspected, and any physical defects, the end of service life, or any similar issues must be immediately replaced with new ones. Under no circumstances should unsuitable personal protective equipment be used.
 - b) Individuals without professional qualifications are not allowed to participate in work that requires a work permit. Therefore, professional qualification certificates related to such work must be kept in the employees' personnel files or uploaded in digital format.
 - Before starting work, it is crucial to verify the validity of professional qualification certificates. Individuals whose certificates have expired or need renewal are not permitted to work on-site.

Use of the Form

The digital work permit form will be filled out using smartphones and sent for approval from the OHS specialist.

The diagram illustrates a digital work permit form with two main input sections and a callout box. The first section is titled "Description of job of work" and contains the instruction "Describe the work(s) you will do in general in this section." Below this is a text input field labeled "Your Answer:". The second section is titled "Working Date and Time*" and contains two input fields: "Date" with the format "DD.MM.YYYY" and a calendar icon, and "Time" with a clock icon. A callout box on the right contains the text: "A GENERAL EXPLANATION SHOULD BE MADE REGARDING THE WORK FOR WHICH PERMISSION IS REQUESTED (INCLUDING THE REASON FOR WORK) AND THE EXACT WORK DATE AND HOUR SHOULD BE SPECIFIED." Two arrows point from this callout box to the "Your Answer:" field and the "Time" field.

Personal Protective Equipment*

Please Tick the Personal Protective Equipment to be Used During Work!

- Earplug & Protective Headphone
- Work Glasses
- Welder Goggles / Barrier
- Safety Helmet
- Dust mask
- Safety Belt
- Work Shoes (General)
- Work shoes (Electrical)
- Safety Glove
- Safety Anti-Static Glove (Electrical-Low Voltage)
- Safety Anti-Static Glove (Electrical-High Voltage)
- Safety Glove (Wloding)
- Isolated Mat
- Insulated Stool
- Protective Work Clothing Against Electric Arc
- Other _____

PERSONAL PROTECTIVE EQUIPMENT TO BE USED DURING WORK SHOULD BE MARKED. MEANWHILE, IT SHOULD BE REMEMBER THAT MORE THAN ONE SELECTION WILL BE MADE AND A VISUAL CHECK OF THE PPE IN SAME SHOULD BE CARRIED OUT BEFORE MARKING.

Certificate Of Professional Competence-01

Are the Professional Competence Certificates of the employees included in their personnel files?

- Yes
- No

IF THE PROFESSIONAL QUALIFICATION DOCUMENTS REGARDING THE PERSONNEL TO BE WORKED ARE AVAILABLE IN THE PEOPLE'S FILE, "YES" SHOULD BE MADE. IF THEY ARE NOT AVAILABLE (EMPLOYERS WITH TEMPORARY WORK ORDER, ETC.), THE SECTION MUST BE MARKED "NO" AND PROCEED TO THE NEXT SECTION.

Certificate Of Professional Competence-01

Please Save the Vocational Competence Certificate in the System!*

Uploadable File Size is Limited to 10 MB. Please Check File Size!.

 Add file

DOCUMENTS OF EMPLOYEES WHO DO NOT HAVE THEIR VOCATIONAL QUALIFICATION CERTIFICATE IN THEIR PERSONNEL FILE (TEMPORARY ASSIGNMENT, ETC.) MUST BE UPLOADED TO THE SYSTEM. DURING UPLOAD, YOU MUST MAKE SURE THE FILE SIZE IS 10MB MAXIMUM, OTHERWISE THE FORM WILL NOT ALLOW THE FILE UPLOAD.

FIELD INFORMATION

Please save the pictures of the area where work will be done to the system.

Uploadable File Size is Limited to 10 MB. Please Check File Size!.



PICTURES OF THE FIELD WHERE WORK WILL BE DONE SHOULD BE UPLOADED TO THE SYSTEM. DURING UPLOAD, YOU MUST MAKE SURE THE IMAGE SIZE IS 10MB MAXIMUM, OTHERWISE THE FORM WILL NOT ALLOW FILE UPLOAD.

The data you enter will be evaluated by our central OHS Experts and if deemed appropriate, approval will be given over the phone. It is forbidden to start work subject to a work permit before the approval procedures are completed.



AFTER FORM DATA ENTRY IS COMPLETED, YOU SHOULD WAIT FOR APPROVAL BY PHONE BY PRESSING THE "SEND" BUTTON.
THE WORKS IN QUESTION CAN BE STARTED AFTER THE APPROVAL.

12. LOTO System

Energetic Systems and devices are used in controlling, maintaining, and replacing natural gas lines, and during these operations, there's a risk of unexpected energy or gas release, operational issues, electrical shock, fire, explosions, etc. To mitigate these risks, physical barriers and informational tags are used together, referred to as LOTO⁸.

During these operations:

- It is mandatory for all personnel involved in the task to receive lockout/tagout training.
- The necessary lockout/tagout equipment must be provided and readily available by the contracting company.
- The neutral and ground lines of the devices should also be disconnected from the bus/connection point. This helps prevent electrical shocks from other systems/devices.
- Valves feeding the section that will be worked on to release energy due to pressure must be closed and locked. Existing pressure should be vented with pressure relief valves or discharged safely.

Figure 13 LOCKOUT TAGGING TRAINING SAMPLE

DANGER
Definitely Don't Operate!
EQUIPMENT LOCKED

TEHLİKE
Kesinlikle Çalıştırma!
Kilitli Durumdadır!

DANGER
Use of this device is prohibited

Kilitleme
Makine, elektrik panosu, şalt ekipmanı, vana vb. ekipmanlara, erişilmesini ve/veya çalıştırılmasını engelleyecek şekilde tasarlanmış kilit mekanizmalarının kullanılmasıdır.
Kilitleme işleminin etiket/uyarı levhaları ile duyurulması gerekmektedir. Aksi takdirde kilitlerin yanlış açılması, zararına gibi durumlarda sorumluluk mutemedir.

The locking process must be announced with labels/warning signs. Otherwise, it is possible to encounter situations such as locks being opened or forced without permission.

Labeling
It is the use of labels that clearly state that actions such as opening, operating, energizing are prohibited for a certain period of time.
It is definitely not recommended to use labels/warning signs alone in high-risk studies.

Etiketleme
Açma, çalıştırma, enerji verme gibi eylemlerin belli bir süre için yasaklandığını açık bir şekilde bildiren etiketlerin kullanılmasıdır.
Yüksek riskli çalışmalarda iş başında etiket/uyarı levhalarının kullanılması kesinlikle önerilmektedir.

Uygun kilitleme elemanlarının sağlanması
Kullanılan ekipmanlar ve prosesler dikkate alınarak uygun kilitleme elemanlarının temin edilmesi ve ihtiyaç halinde kullanıma hazır bulundurulması, işverenin sorumluluğundadır.

Elektrik & Sigorta Kilitleri
Çoklu kilit sistemi ört görsel

Electrical & Insurance Locks
Multiple lock system visual

Providing suitable locking elements
Considering the equipment and processes used; It is the employer's responsibility to provide appropriate locking elements and keep them ready for use when needed.

⁸ lockout/tagout

13. Observation and Inspection

A minimum checklist, as presented below, will be used for routine field inspections. Inspection forms will also be prepared by the contractor as per the nature of the work.

Table 24: OCCUPATIONAL HEALTH AND SAFETY (OHS) CONTROL CHECKLIST

NO	CONTROL SUBJECT	SCORE	DEADLINE	RESPONSIBLE	ACTION
01	Have the necessary OHS trainings been provided to the employees?				
02	Is the continuity of measures taken regarding OHS observed?				
03	Is regular information obtained from employee representatives and support staff about the workplace?				
04	Are employees' entry examinations and periodic examinations conducted regularly?				
05	Are health records stored in accordance with the principle of confidentiality?				
06	Is harmony between work and employees ensured, and guidance provided to protect them from stress factors in the working environment?				
07	Are potential occupational diseases in the sector identified, and workplace observations regarding these diseases conducted?				
08	Are measures identified for controlled entry and exit to the workplace, and is the employer informed?				
09	Are near-miss records evaluated?				
10	Are records of work accidents and occupational diseases evaluated?				
11	Is regular participation ensured in the Occupational Health and Safety Board, and board decisions monitored?				
12	Are occupational health and safety instructions prepared, submitted to the employer for approval, and controlled for implementation?				
13	Are work permit procedures prepared, submitted to the employer for approval, and controlled for implementation?				
14	Are hygiene and safety conditions evaluated for suitable living areas (cafeteria, dormitory, shower, WC, etc.) meeting the legal requirements?				
15	Are environmental physical-chemical-biological factors taken into consideration?				
16	Is the employer informed about the determination of first aid, firefighting, search-rescue-evacuation teams, and the training they receive?				
17	Is the emergency action plan prepared according to the field?				
18	Are escape routes and assembly points determined and marked for emergencies?				
19	Have precautions against fire been taken?				
20	Are emergency drills conducted, monitored, and evaluated?				
21	Is the risk assessment prepared suitable for the field?				
22	Is the risk assessment carried out with the team specified in the legislation?				
23	Are control steps followed after the risk assessment?				
24	Is the risk assessment renewed in cases specified in the legislation?				

NO	CONTROL SUBJECT	SCORE	DEADLINE	RESPONSIBLE	ACTION
25	Is work done for special groups requiring specific policies?				
26	Are suitable Personal Protective Equipment (PPE) selections made for employees, and on-site training provided about their usage?				
27	Are necessary environmental measurements determined at the workplace, and information provided to the employer?				
28	Is information given about the compliance of equipment used in the workplace with standards?				
29	If pedestrian paths and vehicle use are involved, are vehicle paths determined appropriately?				
30	Are suitable storage areas determined for products or equipment to be stored, or parking areas for machinery?				
31	Are periodic inspections of work equipment followed?				
32	Are the competencies of employees using work equipment checked?				
33	Are approved ledger copies kept regularly by the occupational safety specialist and workplace physician during each workplace visit?				
34	Has a realistic annual work plan for the workplace been prepared?				
35	Is the work calendar in the prepared annual work plan followed?				
36	Is there a realistic annual evaluation report for the workplace?				

Inspections carried out by the Consultant and Contractor with OHS Checklists similar to those in Table 24 or improved will be reported to the Project Implementation Unit at the intervals specified in Table 25. The Contractor will submit the reports in the specified format to the Consultant, and the Consultant will submit the final version of the reports to the International Finance Sourced Seismic Reinforcement Department of the Ministry of Environment, Urbanization and Climate Change.

Table 25 OHS Monitoring Plan

What parameter to monitor?	Where to monitor parameters?	How will parameters be monitored?	When will the parameter be monitored (measurement frequency)?	Why will the parameter be monitored?	Reporting	Responsibility
Renovation and Strengthening Works Site Preparation Activities						
Community health and safety management and implemented protection measures	Around the project site	Visual checks Field Control Availability of active Community Safety and Traffic Management Plan	At the beginning of the renovation/reinforcement works (first day) Every working day during project activities	Ensuring that health and safety risks and mechanical injuries to local residents are minimized	<ul style="list-style-type: none"> Weekly 	<ul style="list-style-type: none"> Consultant The Contractor
OSH protection measures applied for workers on construction sites	Project site and buildings near the project site	Visual checks Field Control Availability of OHS plan	Every working day during the project activities	To minimize risks related to occupational health and safety of workers, especially protective equipment and clothing for workers who will remove asbestos-containing roof coverings. Compliance with the Occupational Health and Safety Law, relevant regulations, communiqués, circulars and other regulations.	<ul style="list-style-type: none"> Weekly 	<ul style="list-style-type: none"> Consultant The Contractor
Avoiding and minimizing safety and health risks for Project Affected Persons	In the building and at the project site	Visual checks	At the beginning of the renewal/strengthening work and continuously every working day	Prevent Post Activation Potential (PAP) injury due to inhalation of asbestos fibers or other construction dust	<ul style="list-style-type: none"> Weekly 	<ul style="list-style-type: none"> Consultant The Contractor

What parameter to monitor?	Where to monitor parameters?	How will parameters be monitored?	When will the parameter be monitored (measurement frequency)?	Why will the parameter be monitored?	Reporting	Responsibility
Start and completion time of renovation/reinforcement works and especially dismantling of existing parts containing asbestos	At the project site	Field inspection Review of document records Visual checks	Every day (In case asbestos is detected)	Avoiding environmental, health and safety risks Compliance with the Regulation on Health and Safety Measures in Working with Asbestos	<ul style="list-style-type: none"> Weekly 	<ul style="list-style-type: none"> Consultant The Contractor Asbestos Removal Expert
Renovation/Reinforcement Works Operation Process						
OSH protection measures applied for workers in the field (<i>working at height, working with hazardous substances, working with rotating equipment, working with electrical devices, etc.</i>)	Project site Buildings near the project site	Checking documents regarding relevant OSH Certificates and trained workers Visual checks for the use of protective equipment Implementation of the OSH Plan and site specific Health and Safety instructions Field inspection Control of records	Before starting demolition work Every working day during the project activities	Minimizing risks to workers' occupational health and safety Compliance with the Occupational Health and Safety Law, relevant regulations, communiqués, circulars and other regulations	<ul style="list-style-type: none"> Monthly 	<ul style="list-style-type: none"> Consultant The Contractor

What parameter to monitor?	Where to monitor parameters?	How will parameters be monitored?	When will the parameter be monitored (measurement frequency)?	Why will the parameter be monitored?	Reporting	Responsibility
Job and working conditions	Project site	Final OHS Plan control Field inspection Complaint mechanism (feedbacks)	Every working day during the project activities	Compliance with the Occupational Health and Safety Law, relevant regulations, communiqués, circulars and other regulations	<ul style="list-style-type: none"> • Monthly 	<ul style="list-style-type: none"> • Consultant • The Contractor
Manufacturing, Operation and Delivery (pipeline manufacturing & construction)	In Manufacturing and Building Fields	Visual checks Field Control Records Required Tests Control of Personnel Qualifications Adequacy by the relevant authority	During the relevant manufacturing process in the project and when the manufacturing is completed	Confirming that pipeline construction is complete before delivery. To prevent a possible disaster after production and delivery to the end user.	<ul style="list-style-type: none"> • Reporting 	<ul style="list-style-type: none"> • Beneficiary Institution • Service Provider Institution OHS Department • Consultant • Contractor
Health and Safety records	Project site	Health and Safety construction site documentation control	Weekly	Ensuring that necessary Occupational Health and Safety records are kept at construction sites	<ul style="list-style-type: none"> • Monthly 	<ul style="list-style-type: none"> • Consultant • The Contractor

What parameter to monitor?	Where to monitor parameters?	How will parameters be monitored?	When will the parameter be monitored (measurement frequency)?	Why will the parameter be monitored?	Reporting	Responsibility
Identifying asbestos-containing waste, packaging it properly, labeling it as hazardous waste	At project construction sites Before starting removal/dismantling work	Identification of asbestos-containing waste according to the waste list Field inspection Review of document records	Throughout the project lifecycle/Daily If detected	Regulation on Health and Safety Measures in Working with Asbestos	<ul style="list-style-type: none"> Immediately (if detected) Monthly 	<ul style="list-style-type: none"> Consultant The Contractor
Vehicle and Pedestrian Safety	Project sites and access roads	Visual inspection Using appropriate signs and signals Site inspection Implementation of Community Safety and Traffic Management Plan	Daily	Protecting construction workers, their beneficiaries' employees, and local communities from injuries and deaths related to traffic accidents.	<ul style="list-style-type: none"> Weekly 	<ul style="list-style-type: none"> Contractor Consultant
Renovation/Reinforcement Works Operation Process						
Health and Safety	Renovated/Reinforced buildings	Check the roof, windows, doors, leaks, etc. regular checks and maintenance	Regularly (throughout the life of the project)	Ensuring the health and safety of building residents/users	<ul style="list-style-type: none"> Within 1 week after detection 	Ministry of Youth and Sport
Renovation/Reinforcement Works Operation Process						

What parameter to monitor?	Where to monitor parameters?	How will parameters be monitored?	When will the parameter be monitored (measurement frequency)?	Why will the parameter be monitored?	Reporting	Responsibility
Community health and safety management and implemented protection measures	Around the project site	Visual checks Field Control	At the beginning of the renovation/reinforcement works (first day) Every working day during the project activities	Ensuring that health and safety risks and mechanical injuries to local residents are minimized	<ul style="list-style-type: none"> Weekly 	<ul style="list-style-type: none"> Consultant The contractor
OSH protection measures applied for workers on construction sites	Project site and buildings near the project site	Visual checks Field Control	Every working day during the project activities	To minimize risks related to occupational health and safety of workers, especially protective equipment and clothing for workers who will remove asbestos-containing roof coverings Compliance with the Occupational Health and Safety Law, relevant regulations, communiqués, circulars and other regulations	<ul style="list-style-type: none"> Weekly 	<ul style="list-style-type: none"> Consultant The contractor
Avoiding and minimizing safety and health risks for Project Affected Persons	In the building and at the project site	Visual checks	At the beginning of the renewal/strengthening work and continuously every working day	Prevent Post Activation Potential (PAP) injury due to inhalation of asbestos fibers or other construction dust	<ul style="list-style-type: none"> Weekly 	<ul style="list-style-type: none"> Consultant The contractor

14. Employee Training

- All employees must receive training according to the minimum requirements stated in the "Regulation on the Principles and Procedures of Occupational Health and Safety Training of Employees" (Official Gazette Date: 15.05.2013, Official Gazette Number: 28648) and the "Hygiene Training Regulation" (Official Gazette Date: 05.07.2013, Official Gazette Number: 28698). Training records and certificates of Subcontractor personnel will be requested and checked.

Occupational health and safety training records should include the personnel's name, position, start date, training titles, and dates, and these records should be listed and sent to the consultant Occupational Safety Specialist.

- For this project, all employees will undergo a minimum of 2 person-days of training based on this document and risk analyses. The training will be provided by Contractor and subcontractor Occupational Safety Specialists. Training records will be communicated to the Consultant.
- Employees must have completed Working at Heights Rope Access Training before starting work. This training will be provided by experts holding at least an IRATA (Industrial Rope Access Trade Association) International Level 2 Certificate.

Monitoring Personnel Health Conditions

- Periodic health reports of employees will be checked, and their fitness for the tasks will be verified through these reports.
- Health reports must list the personnel's name, position, start date, occupational health training titles, and dates. These records should be listed and sent to the Consultant Occupational Health Physician.

Personnel Professional Competence

- The required professional competence qualifications are specified in this document. The Contractor company must list all employees, including the personnel's name, position, start date, professional competence certificate, certificate date, and validity period. This list must be submitted to the Consultant Occupational Safety Specialist.

15. Emergency Preparedness

An emergency action plan, as per Article 11 of the Occupational Health and Safety Law No. 6331, will be prepared by the Contractor. This plan will contain specific parameters and instructions for emergencies, mapped and diagrammed. The prepared emergency action plan may vary or be applicable according to the envisaged emergency situations.

During structural reinforcement and renovation works, potential emergencies and preventive measures that may be encountered are provided in the table below:

EMERGENCY	PREVENTIVE AND LIMITING MEASURES
Fire and Explosion	<ul style="list-style-type: none"> • Periodic maintenance and checks of electrical and grounding installations, lightning protection installations, generators, fire extinguishing, and fire detection and warning systems. • Restricting areas where smoking is allowed and marking these areas. • Removing dry grass and tree branches that can catch fire. • Having fire detection and warning systems (alarm, gas, smoke detectors, etc.) and keeping them in continuous working condition. • Periodic checks of the heating system and preventing unauthorized access to boiler rooms. • Proper labeling and storage of chemicals used. • Proper labeling and storage of chemicals. • Proper storage of flammable, combustible, and explosive materials away from heat sources. • Designating the locations of accessible installations such as gas valves and electrical panels for authorized personnel to intervene immediately in case of energy cuts. • Conducting environmental measurements.
Spread from Hazardous Chemicals	<ul style="list-style-type: none"> • Proper storage of chemicals according to their properties and hazards, preventing situations that may cause leaks, and ensuring adequate ventilation. • Preventing unauthorized personnel from entering chemical storage areas. • Providing employees with appropriate personal protective equipment according to standards and ensuring correct usage. • Posting Safety Data Sheets (SDS) in visible locations where chemicals are present in the workspace. • Having an intervention card for hazardous substances. • Conducting environmental measurements.
Poisoning	<ul style="list-style-type: none"> • Checking the expiration dates of food products. • Preparing meals under hygienic conditions. • Keeping materials such as plates, forks, trays, etc., clean. • Taking witness samples from meals. • Providing training to personnel serving meals. • Providing general hygiene training to all personnel. • Meal servers using appropriate gloves, caps, work clothes, etc.
Epidemic Disease	<ul style="list-style-type: none"> • Vaccination. • Preventive medications. • Pest control and disinfection. • Ensuring hygiene. • Establishing a First Aid Team and providing necessary training. • Regular checks of drinking water and water coolers. • Taking witness samples from meals.

Sabotage	<ul style="list-style-type: none"> • Establishing a security unit. • Installing security cameras in necessary locations for continuous monitoring. • Controlled entry and exit. • Keeping records of external persons, checking identities at entry, and issuing visitor cards. • Controlled opening of incoming shipments. • Checking of transport vehicles. • Restricting unauthorized access to high-security areas. • Adequate indoor and outdoor lighting.
Natural Disasters	<ul style="list-style-type: none"> • Strengthening the ground. • Securing cabinets and shelves, placing large tools and equipment in safe positions. • Checking the earthquake resistance of buildings. • Providing training to all employees on what to do in an earthquake. • Having an earthquake bag ready with first aid supplies, flashlight, batteries, radio, etc. • Checking and maintaining rainwater channels. • Prioritizing afforestation. • Portable obstacles for windows and doors in enclosed workplaces. • Using emergency valves for rapid and safe disconnection of electricity (electricity, gas, etc.) and assigning competent individuals. • Having equipment ready for use during and after disasters.
Occupational Accidents	<ul style="list-style-type: none"> • Providing occupational health and safety training. • Conducting health surveillance (periodic examinations and tests, etc.). • Providing additional training for tasks requiring special skills, such as working at heights, working in confined spaces, etc., and having reports demonstrating fitness for these jobs. • Keeping the Risk Assessment up to date and continuously monitoring the measures taken. • Investigating near-miss incidents and taking necessary measures to prevent their recurrence. • Conducting accident investigation and root cause analysis. • Not assigning personnel to tasks they are not qualified for. • Implementing an incentive/warning system for occupational health and safety and working on workplace safety culture. • Implementing an effective inspection mechanism. • Monitoring the correct and active use of Personal Protective Equipment. • Avoiding working alone. • Ensuring that personnel employed through service procurement are employed in compliance with occupational health and safety legislation. • Establishing a First Aid Team and providing necessary training.
Cyber Attacks	<ul style="list-style-type: none"> • Providing employees with training on cyber risks and security. • Installing and keeping antivirus and anti-spyware software up-to-date. • Using a firewall for internet connections. • Updating operating systems and applications. • Regularly backing up data and information. • Controlling physical access to computers and servers. • Ensuring the security and privacy of Wi-Fi and LAN networks. • Assigning individual usernames and passwords to each employee. • Creating authorization levels for accessing information within the network.

General	<ul style="list-style-type: none"> • Posting evacuation plans, entrance and exit of workplace buildings and extensions, floors, and evacuation paths at heights visible to employees. • Indicating the locations of fire extinguishing equipment and first aid materials and evacuation routes on the evacuation plan. • Determining the meeting place after evacuation and showing it on the plan. • Having suitable emergency escape routes and emergency exit doors with appropriate signs. • Placing appropriate signs indicating escape routes in visible places. • Establishing emergency response teams and providing necessary training. • Posting visible contact numbers for emergencies. • Parking vehicles in a way that allows forward movement. • Informing employees about possible emergencies and emergency plans. • Conducting regular emergency drills and ensuring the participation of all employees. • Informing customers, visitors, and other individuals present in the workplace about emergencies and emergency plans. • Keeping emergency plans up-to-date. • Keeping the equipment that emergency teams will use ready for use at all times. • Using a sound and/or light alarm system to alert employees in emergencies. • Marking the location of the First Aid kit, ensuring it is accessible to all employees, ensuring that it contains the necessary number and competence of materials, and continuously checking their expiration dates. • Providing accompaniment for the evacuation of the elderly, disabled, or pregnant individuals.
---------	---

The contractor company must, at a minimum, prepare detailed emergency action plans regarding the above-mentioned issues and forward them to the Consultant OHS Specialist and Workplace Physician.

Muster Points

- Muster points have been determined for each structure and integrated into detailed plans. Emergency gathering areas have been determined taking into account earthquake risks and building dimensions. These locations are indicated using EMERGENCY GATHERING AREA SIGNS in the section titled "Pre-construction Information & Site Plans."

Emergency Response Teams and First Aid Personnel

The contractor and subcontractors must list the names, duties, start dates, dates of emergency preparedness training, and the expiry dates of the first aid certificates of the emergency response teams (ERT) and first aid personnel they have designated, considering legal requirements.

- All these teams must participate in emergency drills at least once, and the participation reports must be submitted to the Consultant OHS Specialist and the Occupational Health Physician.

16. Accident and Incident Investigation

- The report form to be used for investigating and reporting accidents, incidents, and near misses that can occur in the field is given below.
- Major environmental accidents and workplace accidents (such as injuries resulting in death, environmental spills such as spills, etc.) that may occur during construction activities will be shared with the Consultant and CIASB on the same day; it will be reported to the Ministry of Labor and Social Security within 3 working days. CIASB will inform the World Bank about the accident within 48 hours. The contractor will send the accident report to CIASB within 30 working days along with the root cause analysis. CIASB will share this information with the World Bank simultaneously.

The accident report will be completed in accordance with the rules stated below.

The form is titled 'Accident Report Form' and includes the following sections:

- Company Name:** _____
- Incident Location:** _____
- Event Date/Time:** ____/____/____
- Report Date/Time:** ____/____/____
- Report Prepared By:** _____
- Duty:** _____
- CASUALTY INFORMATION:**
 - Name (surname):** _____
 - ID Number:** _____
 - Start date of work:** ____/____/____
 - Insurance Agency No.:** _____
- INCIDENT ANALYSIS:**
 - Incident Code:** _____
 - The Accident Code will be determined by evaluating the "Accident Code" given below:**

PERSONNEL DAMAGE	PROPERTY DAMAGE	ENVIRONMENTAL DAMAGE
1. THERE IS NO INJURY OR DEATH	1. THERE IS NO DAMAGE	1. THERE IS NO ENVIRONMENTAL DAMAGE
2. MINOR INJURY OR DEATH	2. DAMAGE TO ONE OF THE PROPERTIES	2. DAMAGE TO ONE OF THE ENVIRONMENTAL ELEMENTS
3. MODERATE INJURY OR DEATH	3. DAMAGE BETWEEN ONE TO THREE OF THE PROPERTIES	3. DAMAGE BETWEEN ONE TO THREE OF THE ENVIRONMENTAL ELEMENTS
4. SEVERE INJURY OR DEATH	4. DAMAGE BETWEEN FOUR TO SEVEN OF THE PROPERTIES	4. DAMAGE BETWEEN FOUR TO SEVEN OF THE ENVIRONMENTAL ELEMENTS
5. FATAL INJURY OR DEATH	5. DAMAGE BETWEEN EIGHT TO TEN OF THE PROPERTIES	5. DAMAGE BETWEEN EIGHT TO TEN OF THE ENVIRONMENTAL ELEMENTS
6. FATAL INJURY OR DEATH	6. DAMAGE BETWEEN ELEVEN TO FIFTEEN OF THE PROPERTIES	6. DAMAGE BETWEEN ELEVEN TO FIFTEEN OF THE ENVIRONMENTAL ELEMENTS
7. FATAL INJURY OR DEATH	7. DAMAGE BETWEEN SIXTEEN TO TWENTY OF THE PROPERTIES	7. DAMAGE BETWEEN SIXTEEN TO TWENTY OF THE ENVIRONMENTAL ELEMENTS
8. FATAL INJURY OR DEATH	8. DAMAGE BETWEEN TWENTY-ONE TO TWENTY-FIVE OF THE PROPERTIES	8. DAMAGE BETWEEN TWENTY-ONE TO TWENTY-FIVE OF THE ENVIRONMENTAL ELEMENTS
9. FATAL INJURY OR DEATH	9. DAMAGE BETWEEN TWENTY-SIX TO THIRTY OF THE PROPERTIES	9. DAMAGE BETWEEN TWENTY-SIX TO THIRTY OF THE ENVIRONMENTAL ELEMENTS
10. FATAL INJURY OR DEATH	10. DAMAGE BETWEEN THIRTY-ONE TO THIRTY-FIVE OF THE PROPERTIES	10. DAMAGE BETWEEN THIRTY-ONE TO THIRTY-FIVE OF THE ENVIRONMENTAL ELEMENTS
11. FATAL INJURY OR DEATH	11. DAMAGE BETWEEN THIRTY-SIX TO FORTY OF THE PROPERTIES	11. DAMAGE BETWEEN THIRTY-SIX TO FORTY OF THE ENVIRONMENTAL ELEMENTS
12. FATAL INJURY OR DEATH	12. DAMAGE BETWEEN FORTY-ONE TO FORTY-FIVE OF THE PROPERTIES	12. DAMAGE BETWEEN FORTY-ONE TO FORTY-FIVE OF THE ENVIRONMENTAL ELEMENTS
13. FATAL INJURY OR DEATH	13. DAMAGE BETWEEN FORTY-SIX TO FIFTY OF THE PROPERTIES	13. DAMAGE BETWEEN FORTY-SIX TO FIFTY OF THE ENVIRONMENTAL ELEMENTS
14. FATAL INJURY OR DEATH	14. DAMAGE BETWEEN FIFTY-ONE TO FIFTY-FIVE OF THE PROPERTIES	14. DAMAGE BETWEEN FIFTY-ONE TO FIFTY-FIVE OF THE ENVIRONMENTAL ELEMENTS
15. FATAL INJURY OR DEATH	15. DAMAGE BETWEEN FIFTY-SIX TO SIXTY OF THE PROPERTIES	15. DAMAGE BETWEEN FIFTY-SIX TO SIXTY OF THE ENVIRONMENTAL ELEMENTS
16. FATAL INJURY OR DEATH	16. DAMAGE BETWEEN SIXTY-ONE TO SIXTY-FIVE OF THE PROPERTIES	16. DAMAGE BETWEEN SIXTY-ONE TO SIXTY-FIVE OF THE ENVIRONMENTAL ELEMENTS
17. FATAL INJURY OR DEATH	17. DAMAGE BETWEEN SIXTY-SIX TO SEVENTY OF THE PROPERTIES	17. DAMAGE BETWEEN SIXTY-SIX TO SEVENTY OF THE ENVIRONMENTAL ELEMENTS
18. FATAL INJURY OR DEATH	18. DAMAGE BETWEEN SEVENTY-ONE TO SEVENTY-FIVE OF THE PROPERTIES	18. DAMAGE BETWEEN SEVENTY-ONE TO SEVENTY-FIVE OF THE ENVIRONMENTAL ELEMENTS
19. FATAL INJURY OR DEATH	19. DAMAGE BETWEEN SEVENTY-SIX TO EIGHTY OF THE PROPERTIES	19. DAMAGE BETWEEN SEVENTY-SIX TO EIGHTY OF THE ENVIRONMENTAL ELEMENTS
20. FATAL INJURY OR DEATH	20. DAMAGE BETWEEN EIGHTY-ONE TO EIGHTY-FIVE OF THE PROPERTIES	20. DAMAGE BETWEEN EIGHTY-ONE TO EIGHTY-FIVE OF THE ENVIRONMENTAL ELEMENTS
21. FATAL INJURY OR DEATH	21. DAMAGE BETWEEN EIGHTY-SIX TO NINETY OF THE PROPERTIES	21. DAMAGE BETWEEN EIGHTY-SIX TO NINETY OF THE ENVIRONMENTAL ELEMENTS
22. FATAL INJURY OR DEATH	22. DAMAGE BETWEEN NINETY-ONE TO NINETY-FIVE OF THE PROPERTIES	22. DAMAGE BETWEEN NINETY-ONE TO NINETY-FIVE OF THE ENVIRONMENTAL ELEMENTS
23. FATAL INJURY OR DEATH	23. DAMAGE BETWEEN NINETY-SIX TO ONE HUNDRED OF THE PROPERTIES	23. DAMAGE BETWEEN NINETY-SIX TO ONE HUNDRED OF THE ENVIRONMENTAL ELEMENTS

Affected body parts: _____

Author and person who prepared the form: _____

- Care must be taken to fill out all sections of the accident report completely.
- The accident code must be determined and defined according to the procedure specified in the report.
- The sections where the injured person is injured must be indicated on the first page on the graphic, and the information about the injury must be described in accordance with the procedure specified in the report.
- The elements causing the accident must be selected from the list specified on page 2 of the Accident Report.
- When describing the accident and the root causes causing the accident on page 3, great care must be taken, the accident must be thoroughly investigated, and care must be taken not to use expressions that can be misunderstood.
- Two personnel who witnessed the accident must be identified on page 3 of the Accident Report.
- If the number of personnel witnessing the accident is more than 2, efforts should be made to select neutral personnel who can describe the accident appropriately from among the witnesses.
- Witnesses described on page 3 must sign the ACCIDENT RECORD given on page 7.
- Incident site photos, photos of the injured, photos of the device causing the accident, equipment, etc., objective evidence must be provided and attached to page 4 of the Report. If the number of photos is high, important photos should be specified in this section, and other photos should be kept in the appendix of the report. (A note stating that additional photos are available in the report appendix should be written at the bottom of page 4.)
- The PPE used by the personnel during the accident must be specified on page 5 of the report. In this section, the PPE used by the personnel, not the PPE delivered to the personnel, must be identified with care. The report appendix will contain the minutes related to the PPE delivered to the personnel.
- Measures to be taken immediately after the accident and measures to prevent the accident from recurring must be specified separately on page 6 of the Accident Report.

- If possible, the personnel who directly experienced the accident must fill out the accident record given on page 7. If this is not possible, selected personnel among the witnesses specified in the report must fill out this section in their own handwriting. If there are no witnesses to the accident, the employer or employer representatives will be asked to fill out this section in their own handwriting.
- The prepared report must be signed by the OHS Specialist, Occupational Health Physician, Employer/Employer Representative.
- The following documents must be included in the prepared Accident Report appendix:
 - PPE delivery report,
 - Participation forms and certificates regarding the training given until the accident date,
 - Orientation training form,
 - Certificates, diplomas regarding professional competence,
 - Health report showing suitability for the job,
 - Overtime work approval form (if the accident occurs outside working hours),
 - Pre-prepared warning letters (if related to the cause of the accident),
 - Records prepared regarding occupational health and safety,
 - SSI occupational accident notification form,
 - Health report obtained after the accident,
 - Physician's report indicating work disability,
 - Insured job entry declaration.

It should not be forgotten that accidents can happen no matter what kind of precautions are taken. It is important to act calmly during and after the accident, both for the injured person and for the company. Therefore, it is recommended to conduct EMERGENCY RESCUE drills with dignity before fieldwork related to WORK ACCIDENTS/RESCUE OF INJURED PERSONS.

Post-accident measures: corrections that need to be made urgently and corrections aimed at eliminating the ROOT cause that caused the accident should be evaluated in two separate categories. After a work accident, it is essential to eliminate the elements that caused the accident in a way that will not be repeated.

Post-Accident Considerations;

- During inspections, necessary arrangements will be made in the field to facilitate inspectors' access to the site. All information and documents related to the injured person will be readily available. It should be noted that the access time to the information and documents requested by the inspector is crucial.
- The occupational accident notification to the Social Security Institution (SSI) will be made within a maximum of 3 days from the accident date. (Together with the visit report)
- If available, control reports of the machinery and equipment causing the accident and regular maintenance records will also be kept in the accident report for inspections.
- All documents kept in the Accident Report appendix will be copies. However, necessary preparations will be made to provide access to the original documents to the inspectors if requested.

17. OHS Budget

The OHS Budget presented below has been created for general informative purposes. It is assumed that the bid to be submitted by the contractor includes the budget necessary for taking measures related to occupational health and safety.

Table 26 Estimated OHS Budget

	AMOUNT	UNIT	UNIT PRICE	VALUE
CATEGORY II HELMET (TS EN 397+A1)	360	AD.	₺200,00	₺72.000,00
CATEGORY I EARPLUG (TS EN 352-2)	10150	AD.	₺15,00	₺152.250,00
CATEGORY I PROTECTIVE GOGGLES (TS EN ISO 16321-3)	320	AD.	₺60,00	₺19.200,00
GENERAL PURPOSE WORK GLOVES (TS EN ISO 21420)	320	AD.	₺30,00	₺9.600,00
ELECTRICAL WORK GLOVES (LOW VOLTAGE) (TS EN ISO 21420)	80	AD.	₺750,00	₺60.000,00
WORK SHOES (TS EN ISO 20347)	320	AD.	₺450,00	₺144.000,00
ISOLATED WORK SHOES (LOW VOLTAGE) (TS EN ISO 20347)	60	AD.	₺1.100,00	₺66.000,00
DUST MASK	10150	AD.	₺5,00	₺50.750,00
HALF FACE MASK (TS EN 140)	110	AD.	₺500,00	₺50.500,00
CATEGORY II FULL BODY SAFETY HARNESS (TS EN 361)	175	AD.	₺450,00	₺78.750,00
FALL ARREST DEVICES (EN 355)	200	AD.	₺250,00	₺50.000,00
LIFE LINES (EN 355)	250	m.	₺450,00	₺112.500,00
SAFETY STRAP	1200	m.	₺2,50	₺3.000,00
SAFETY NET (EN 355)	250	m ²	₺350,00	₺87.500,00

TOPLAM: **₺956.050,00**
KDV: **₺191.210,00**
YEKÜN: **₺1.147.260,00**

Annex-1 Traffic Plan, Emergency Gathering Area, Risky Areas

Regarding the structures within the scope of the Istanbul University Cerrahpaşa Rectorate Avclar Campus project; Sections of the construction site traffic plan, parking areas, emergency meeting areas and dangerous elevation differences are presented to your attention below;

Figure 14 Kocaeli- Ministry Of Youth And Sports Kandira Special Provincial Administration Kyk Dormitory Traffic Plan



Figure 15 Kocaeli Gsb Kandira Special Provincial Administration Kyk Dormitory Emergency Assembly Area



Figure 16 KOCAELİ GSB KANDIRA PROVINCIAL SPECIAL ADMINISTRATION KYK DORMITORY Risky Areas

